

## Test Verification of Conformity

On the basis of the referenced test report(s), the sample(s) of the below product has been found to comply with the relevant harmonized standard(s) to the directive(s) listed on this verification at the time the tests were carried out. The manufacturer may indicate compliance to only the said directives by signing a DoC himself and may affix the CE marking to products identical to the tested sample(s) if the product complies with all CE marking directives that has the product in their scope. In addition, the manufacturer shall file and keep the documentation according to the rules of the applicable directive(s) and shall consider changes of the standards as they may occur. Additional requirements, additional directives and local laws may be applicable.

<b>Applicant Name &amp; Address</b>	: Eaglerise Electronics (Foshan) Co., Ltd. No. 4, East Huanzhen Road, Beijiao, Shunde, Foshan, Guangdong, 528000, China
<b>Product(s) Tested</b>	: Electronic controlgear for LED (Electronic LED driver)
<b>Ratings and principal characteristics</b>	: See Annex to Test Verification of Conformity
<b>Model(s)</b>	: See Annex to Test Verification of Conformity
<b>Brand name</b>	: 
<b>Relevant Standard(s) / Specification(s) / Directive(s)</b>	: EN 55015: 2006+A1: 2007+A2: 2009/ Limits and methods of measurement of radio disturbance characteristics of electrical lighting and similar equipment  EN 61000-3-2: 2006+ A1: 2009+ A2: 2009/ Electromagnetic compatibility (EMC) – Part 3-2: Limits – Limits for harmonic current emissions (equipment input current ≤ 16 A per phase)  EN 61000-3-3: 2008/ Electromagnetic compatibility (EMC) – Part 3-3: Limits – Limitation of voltage changes, voltage fluctuations and flicker in public low-voltage supply systems, for equipment with rated current ≤ 16 A per phase and not subject to conditional connection  EN 61547: 2009/ Equipment for general lighting purposes — EMC immunity requirements  EMC Directive 2004/108/EC
<b>Verification Issuing Office Name &amp; Address</b>	: Same as Legal Entity
<b>Verification/Report Number(s)</b>	: GZ12061376-1/ GZ12061376-1

**Note 1 :** This verification is part of the full test report(s) and should be read in conjunction with it.

This Verification is for the exclusive use of Intertek's Client and is provided pursuant to the agreement between Intertek and its Client. Intertek's responsibility and liability are limited to the terms and conditions of the agreement. Intertek assumes no liability to any party, other than to the Client in accordance with the agreement, for any loss, expense or damage occasioned by the use of this Verification. Only the Client is authorized to copy or distribute this Verification. Any use of the Intertek name or one of its marks for the sale or advertisement of the tested material, product or service must first be approved in writing by Intertek. The observations and test results referenced from this Verification are relevant only to the sample tested. This Verification by itself does not imply that the material, product, or service is or has ever been under an Intertek certification program.

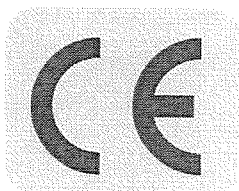

Signature

Name: Carrie Chen  
 Position: Technical Supervisor  
 Date: 14 Aug., 2012

P. 1 of 2

## Annex to Test Verification of Conformity

This is an Annex to Test Verification of Conformity with Verification/Report Number(s): GZ12061376-1/ GZ12061376-1. The issuing office is Intertek Testing Services Shenzhen Ltd. Guangzhou Branch (Address: Block E, No, 7-2 Guang Dong Software Science Park, Caipin Road Guangzhou Science City, GETDD Guangzhou).

<b>Ratings and principal characteristics</b>	:	Input: 220-240 VAC; 50/60 Hz; 0,15 A; Class II; IP 20; SELV; ta 50 °C; tc 80 °C; Independent type; 110 °C thermal protection; Inherently short-circuit proof; MM mark; Output: Constant current type for output; Suitable for direct mounting on normally flammable surfaces
<b>Model(s)</b>	:	EIP016C****LS Remark: The 1st to 4th "*" indicate the output current of LED driver; can be replaced by "0350" to "1400" and increasing in multiplies of 50. "0350" means 350 mA; "1400" means 1400 mA.

**Note 1:** This annex is part of the Test Verification of Conformity and should be read in conjunction with it.

This Verification is for the exclusive use of Intertek's Client and is provided pursuant to the agreement between Intertek and its Client. Intertek's responsibility and liability are limited to the terms and conditions of the agreement. Intertek assumes no liability to any party, other than to the Client in accordance with the agreement, for any loss, expense or damage occasioned by the use of this Verification. Only the Client is authorized to copy or distribute this Verification. Any use of the Intertek name or one of its marks for the sale or advertisement of the tested material, product or service must first be approved in writing by Intertek. The observations and test results referenced from this Verification are relevant only to the sample tested. This Verification by itself does not imply that the material, product, or service is or has ever been under an Intertek certification program.



Signature

Name: Carrie Chen  
Position: Technical Supervisor  
Date: 14 Aug., 2012

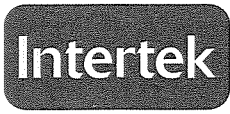

**TEST REPORT**

Applicant Name & Address : Eaglerise Electronics (Foshan) Co., Ltd.  
 No. 4, East Huanzhen Road, Beijiao, Shunde, Foshan, Guangdong, 528000, China

Manufacturing Site : Same as applicant

Sample Description  
 Product : Electronic controlgear for LED (Electronic LED driver)  
 Model No. : EIP016C\*\*\*\*LS  
 Remark:  
 The 1st to 4th "\*" indicate the output current of LED driver; can be replaced by "0350" to "1400" and increasing in multiplies of 50. "0350" means 350 mA; "1400" means 1400 mA.

Electrical Rating : Input: 220-240 VAC; 50/60 Hz; 0,15 A; Class II; IP 20; SELV; ta 50 °C; tc 80 °C; Independent type; 110 °C thermal protection; Inherently short-circuit proof; Output: Constant current type for output; MM mark; Suitable for direct mounting on normally flammable surfaces; Other parameters refer to appendix for model list in test report.

Date Received : 21 June 2012  
 Date Test Conducted : 09 July 2012 – 11 July 2012  
 Test standards : EN 55015: 2006+A1: 2007+A2: 2009  
 EN 61000-3-2: 2006+ A1:2009+ A2:2009  
 EN 61000-3-3: 2008  
 EN 61547: 2009

Test Result : Pass  
 Conclusion : The submitted samples complied with the above EMC standards.  
 Remark : None.

\*\*\*\*\*End of Page\*\*\*\*\*

*Prepared and Checked By:*

*Approved By:*

Helen Ma  
 Helen Ma  
 Project Engineer  
 Intertek Guangzhou

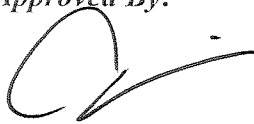
  
 Carrie Chen  
 Technical Supervisor  
 Intertek Guangzhou  
 14 Aug., 2012  
 Signature  
 Date

This report is for the exclusive use of Intertek's Client and is provided pursuant to the agreement between Intertek and its Client. Intertek's responsibility and liability are limited to the terms and conditions of the agreement. Intertek assumes no liability to any party, other than to the Client in accordance with the agreement, for any loss, expense or damage occasioned by the use of this report. Only the Client is authorized to permit copying or distribution of this report and then only in its entirety. Any use of the Intertek name or one of its marks for the sale or advertisement of the tested material, product or service must first be approved in writing by Intertek. The observations and test results in this report are relevant only to the sample tested. This report by itself does not imply that the material, product, or service is or has ever been under an Intertek certification program. The test report only allows to be revised within three years from its original issued date unless further standard or the requirement was noticed.

## CONTENT

<b>TEST REPORT</b> .....	<b>1</b>
<b>CONTENT</b> .....	<b>2</b>
<b>1 TEST RESULTS SUMMARY</b> .....	<b>4</b>
<b>2 EMC RESULTS CONCLUSION</b> .....	<b>5</b>
<b>3 LABORATORY MEASUREMENTS</b> .....	<b>6</b>
<b>4 EMI TEST</b> .....	<b>7</b>
4.1 EN 55015 CONTINUOUS CONDUCTED DISTURBANCE VOLTAGE TEST .....	7
4.1.1 <i>Used Test Equipment</i> .....	7
4.1.2 <i>Block Diagram of Test Setup</i> .....	7
4.1.3 <i>Test Setup and Procedure</i> .....	7
4.1.4 <i>Test Data</i> .....	8
4.1.5 <i>Emission Curve</i> .....	13
4.1.6 <i>Measurement Uncertainty</i> .....	16
4.2 EN 55015 RADIATED ELECTROMAGNETIC DISTURBANCE (9 KHZ-30 MHZ).....	16
4.2.1 <i>Used Test Equipment</i> .....	16
4.2.2 <i>Block Diagram of Test Setup</i> .....	16
4.2.3 <i>Test Setup and Procedure</i> .....	16
4.2.4 <i>Test Data</i> .....	17
4.2.5 <i>Test Curve</i> .....	18
4.2.6 <i>Measurement Uncertainty</i> .....	22
4.3 EN 55015 RADIATED ELECTROMAGNETIC DISTURBANCE (30 MHZ -300 MHZ, CDN METHOD) .....	23
4.3.1 <i>Used Test Equipment</i> .....	23
4.3.2 <i>Block Diagram of Test Setup</i> .....	23
4.3.3 <i>Test Setup and Procedure</i> .....	23
4.3.4 <i>Test Data</i> .....	24
4.3.5 <i>Test Curve</i> .....	25
4.3.6 <i>Measurement uncertainty</i> .....	26
4.4 INSERTION LOSS .....	26
<b>5 HARMONICS OF CURRENT</b> .....	<b>27</b>
5.1 USED TEST EQUIPMENT.....	27
5.2 BLOCK DIAGRAM OF TEST SETUP .....	27
5.3 TEST SETUP AND PROCEDURE .....	27
<b>6 FLICKER</b> .....	<b>28</b>
6.1 USED TEST EQUIPMENT.....	28
6.2 BLOCK DIAGRAM OF TEST SETUP .....	28
6.3 TEST SETUP AND PROCEDURE .....	28
6.3.1 <i>Definition</i> .....	28
6.3.2 <i>Test condition</i> .....	28
6.1 EN 61000-4-2(PURSUANT TO EN 61547) ELECTROSTATIC DISCHARGE IMMUNITY .....	29
6.1.1 <i>Used Test Equipment</i> .....	29
6.1.2 <i>Block Diagram of Test Setup</i> .....	30
6.1.3 <i>Test Setup and Procedure</i> .....	30
6.1.4 <i>Test Result</i> .....	32
6.2 EN 61000-4-6(PURSUANT TO EN 61547) INJECTED CURRENT (0.15 MHZ TO 80 MHZ) .....	33
6.2.1 <i>Used Test Equipment</i> .....	33
6.2.2 <i>Block Diagram of Test Setup</i> .....	33
6.2.3 <i>Test Setup and Procedure</i> .....	33
6.2.4 <i>Test Result</i> .....	34
6.3 EN 61000-4-4(PURSUANT TO EN 61547) ELECTRICAL FAST TRANSIENT/BURST .....	34

- 6.3.1 *Used Test Equipment* ..... 34
- 6.3.2 *Block Diagram of Test Setup*..... 34
- 6.3.3 *Test Setup and Procedure* ..... 35
- 6.3.4 *Test Result*..... 35
- 6.4 EN 61000-4-5(PURSUANT TO EN 61547) SURGE IMMUNITY ..... 36
  - 6.4.1 *Used Test Equipment* ..... 36
  - 6.4.2 *Block Diagram of Test Setup*..... 36
  - 6.4.3 *Test Setup and Procedure* ..... 36
  - 6.4.4 *Test Result*..... 37
- 6.5 EN 61000-4-11(PURSUANT TO EN 61547) VOLTAGE DIPS AND INTERRUPTIONS ..... 37
  - 6.5.1 *Used Test Equipment* ..... 37
  - 6.5.2 *Block Diagram of Test Setup*..... 37
  - 6.5.3 *Test Setup and Procedure* ..... 38
  - 6.5.4 *Test Result*..... 38
- 6.6 EN 61000-4-3(PURSUANT TO EN 61547) RADIATED ELECTROMAGNETIC FIELD IMMUNITY ..... 39
  - 6.6.1 *Used Test Equipment* ..... 39
  - 6.6.2 *Block Diagram of Test Setup*..... 39
  - 6.6.3 *Test Setup and Procedure* ..... 40
  - 6.6.4 *Test Result*..... 40
- 6.7 EN 61000-4-8(PURSUANT TO EN 61547) POWER FREQUENCY MAGNETIC FIELD IMMUNITY ..... 41
- 7 APPENDIX I - PHOTOS OF TEST SETUP** ..... **42**
- 8 APPENDIX II- PHOTOS OF EUT**..... **46**

**TEST RESULTS SUMMARY**

<b>Test Item</b>	<b>Standard</b>	<b>Result</b>
<b>Continuous conducted disturbance voltage</b>	EN 55015: 2006+A1: 2007+A2: 2009	<b>Pass</b>
<b>Radiated electromagnetic disturbance (9 kHz -30 MHz)</b>	EN 55015: 2006+A1: 2007+A2: 2009	<b>Pass</b>
<b>Radiated Electromagnetic Disturbance (30 MHz -300 MHz)</b>	EN 55015: 2006+A1: 2007+A2: 2009	<b>Pass</b>
<b>Insertion loss</b>	EN 55015: 2006+A1: 2007+A2: 2009	<b>N/A</b>
<b>Harmonic of current</b>	EN 61000-3-2: 2006+ A1:2009+ A2:2009	<b>Pass</b>
<b>Flicker</b>	EN 61000-3-3: 2008	<b>Pass</b>
<b>ESD immunity</b>	EN 61547:2009 Reference: EN 61000-4-2: 2009	<b>Pass</b>
<b>Radiated EM filed immunity</b>	EN 61547:2009 Reference: EN 61000-4-3:2006+A1 :2008	<b>Pass</b>
<b>EFT immunity</b>	EN 61547:2009 Reference: EN 61000-4-4:2004	<b>Pass</b>
<b>Surge immunity</b>	EN 61547:2009 Reference: EN 61000-4-5:2006	<b>Pass</b>
<b>Inject current immunity</b>	EN 61547:2009 Reference: EN 61000-4-6:2009	<b>Pass</b>
<b>Power frequency magnetic field immunity</b>	EN 61547:2009 Reference: EN 61000-4-8:1993+A1:2001	<b>N/A</b>
<b>Voltage dips and interruption immunity</b>	EN 61547:2009 Reference: EN 61000-4-11:2004	<b>Pass</b>

Remark: 1. The symbol “N/A” in above table means Not Applicable.  
 2. When determining the test results, measurement uncertainty of tests has been considered.

**2****EMC Results Conclusion**  
(with Justification)

RE: EMC Testing Pursuant to EMC Directive 2004/108/EC Performed on the Electronic controlgear for LED (Electronic LED driver), Models: EIP016C\*\*\*\*LS.

We tested the Electronic controlgear for LED (Electronic LED driver), Model: EIP016C1400LS, EIP016C0600LS, EIP016C0350LS, to determine if there were in compliance with the relevant EN standards as marked on the Test Results Summary. We found that the units met the requirement of EN 55015, EN 61000-3-2, EN 61000-3-3, EN 61547 (EN 61000-4-2), EN 61547 (EN 61000-4-4), EN 61547 (EN 61000-4-6), EN 61547 (EN 61000-4-5), EN 61547 (EN 61000-4-11), & EN 61547 (EN 61000-4-3) standards when tested as received. The worst case's test data was presented in this test report. Test items Radiated Electromagnetic Disturbance (30 MHz -300 MHz) and Radiated EM filed immunity were subcontracted.

All models had the same mechanical structure, output load, PCB layout; the only deference is the parameters for the components used in secondary circuit. Model: EIP016C1400LS, EIP016C0600LS, EIP016C0350LS were selected to do the full tests based on above statement.

The production units are required to conform to the initial sample as received when the units are placed on the market.

## 3

**LABORATORY MEASUREMENTS****Configuration Information**

<b>Equipment Under Test (EUT):</b>	Electronic controlgear for LED (Electronic LED driver)
<b>Model:</b>	EIP016C1400LS, EIP016C0600LS, EIP016C0350LS
<b>Serial No.</b>	Not Labeled
<b>Support Equipment:</b>	N/A
<b>Rated Voltage:</b>	220-240V, 50/60Hz
<b>Condition of Environment:</b>	Temperature : 15~25°C Relative Humidity: 35~60% Atmosphere Pressure 86~106kPa

**Notes:**

1. The EMI measurements had been made in the operating mode produced the largest emission in the frequency band being investigated consistent with normal applications.

An attempt had been made to maximize the emission by varying the configuration of the EUT.

2. The EMS measurements had been made in the frequency bands being investigated, with the EUT in the most susceptible operating mode consistent with normal applications. The configuration of the test sample had been varied to achieve maximum susceptibility.



## 4 EMI TEST

### 4.1 EN 55015 Continuous Conducted Disturbance Voltage Test

**Test Result: Pass**

#### 4.1.1 Used Test Equipment

Equipment No.	Equipment	Model	Manufacturer
EM080-05	EMI receiver	ESCI	R&S
EM006-05	LISN	ENV216	R&S
EM004-04	EMC shield Room	8m×3m×3m	Zhongyu

#### 4.1.2 Block Diagram of Test Setup

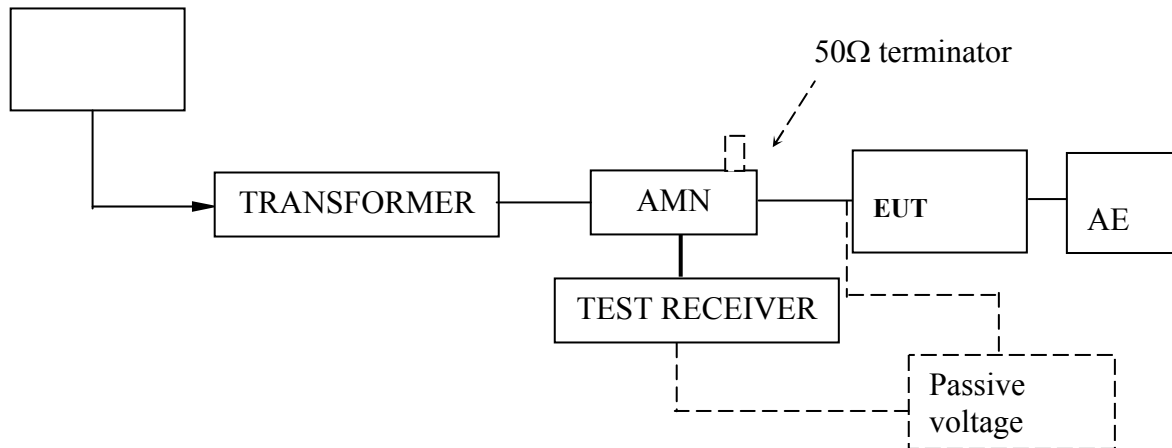

#### 4.1.3 Test Setup and Procedure

The EUT was set to achieve the maximum emission level. The mains terminal disturbance voltage was measured with the EUT in a shielded room. The EUT was connected to AC power source through an Artificial Mains Network which provide a 50Ω linear impedance. Artificial hand is used if appropriate (for handheld apparatus). The load/control terminal disturbance voltage was measured with passive voltage probe if appropriate.

The EUT was placed on a 0.4m high non-metallic table above a metallic plane, and 0.4m from wall of shielded room which is considered as Ground Reference Plane (GRP) (For floor standing EUT, was placed on a 0.1m high non-metallic supported on GRP) The EUT keeps a distance of at least 0.8m from any other of the metallic surface. The Artificial Mains Network is situated at a distance of 0.8m from the EUT.

During the test, mains lead of EUT excess 0.8m was folded back and forth parallel to the lead so as to form a horizontal bundle with a length between 0.3m and 0.4m.

The bandwidth of test receiver was set at 200Hz in the frequency range from 9kHz to 150kHz, and 9kHz in the frequency range from 150kHz to 30MHz.

**4.1.4 Test Data**

**At main terminal: Pass**

**Model: EIP016C1400LS**

**Tested Wire: Live**

**Operation Mode: on mode**

Frequency [MHz]	Quasi-Peak		Average	
	Disturbance level [dB(μV)]	Permitted limit [dB(μV)]	Disturbance level [dB(μV)]	Permitted limit [dB(μV)]
0.009	<60	110.0	--	--
0.050	<50	90.0	--	--
0.100	<50	83.7	--	--
0.160	<40	65.5	<30	55.5
0.240	<40	62.1	<30	52.1
0.550	<40	56.0	<30	46.0
1.000	<40	56.0	<30	46.0
1.400	<40	56.0	<30	46.0
2.000	<40	56.0	<30	46.0
3.500	<40	56.0	<30	46.0
6.000	<40	60.0	<30	50.0
10.000	<40	60.0	<30	50.0
22.000	<40	60.0	<30	50.0
30.000	<40	60.0	<30	50.0

**Tested Wire: Neutral**
**Operation Mode: on mode**

Frequency [MHz]	Quasi-Peak		Average	
	Disturbance level [dB(μV)]	Permitted limit [dB(μV)]	Disturbance level [dB(μV)]	Permitted limit [dB(μV)]
0.009	<60	110.0	--	--
0.050	<50	90.0	--	--
0.100	<50	83.7	--	--
0.160	<40	65.5	<30	55.5
0.240	<40	62.1	<30	52.1
0.550	<40	56.0	<30	46.0
1.000	<40	56.0	<30	46.0
1.400	<40	56.0	<30	46.0
2.000	<40	56.0	<30	46.0
3.500	<40	56.0	<30	46.0
6.000	<40	60.0	<30	50.0
10.000	<40	60.0	<30	50.0
22.000	<40	60.0	<30	50.0
30.000	<40	60.0	<30	50.0



**Model: EIP016C0600LS**

**Tested Wire: Live**

**Operation Mode: on mode**

EDIT PEAK LIST (Final Measurement Results)				
Trace1:	CE1511QP			
Trace2:	CE1511AV			
Trace3:	---			
TRACE	FREQUENCY	LEVEL dB $\mu$ V		DELTA LIMIT dB
2 Average	150 kHz	42.71	L1	-13.28
1 Quasi Peak	154 kHz	50.75	L1	-15.02
1 Quasi Peak	198 kHz	44.51	L1	-19.18
1 Quasi Peak	514 kHz	36.29	L1	-19.70
1 Quasi Peak	522 kHz	36.33	L1	-19.66
2 Average	16.03 MHz	25.16	L1	-24.83
1 Quasi Peak	19.738 MHz	42.82	L1	-17.17

**Tested Wire: Neutral**

**Operation Mode: on mode**

EDIT PEAK LIST (Final Measurement Results)				
Trace1:	CE1511QP			
Trace2:	CE1511AV			
Trace3:	---			
TRACE	FREQUENCY	LEVEL dB $\mu$ V		DELTA LIMIT dB
2 Average	150 kHz	38.44	L1	-17.55
1 Quasi Peak	510 kHz	35.28	L1	-20.71
1 Quasi Peak	526 kHz	35.63	L1	-20.36
1 Quasi Peak	2.346 MHz	39.14	L1	-16.85
2 Average	16.01 MHz	35.65	L1	-14.34
1 Quasi Peak	19.682 MHz	42.51	L1	-17.48



**Model: EIP016C0350LS**

**Tested Wire: Live**

**Operation Mode: on mode**

EDIT PEAK LIST (Final Measurement Results)				
Trace1:	CE1511QP			
Trace2:	CE1511AV			
Trace3:	---			
TRACE	FREQUENCY	LEVEL dBμV		DELTA LIMIT dB
1 Quasi Peak	154 kHz	50.02	L1	-15.75
2 Average	170 kHz	40.44	L1	-14.51
1 Quasi Peak	302 kHz	42.34	L1	-17.84
1 Quasi Peak	326 kHz	41.70	L1	-17.85
1 Quasi Peak	530 kHz	37.98	L1	-18.01
1 Quasi Peak	930 kHz	40.88	L1	-15.11
1 Quasi Peak	2.178 MHz	44.43	L1	-11.56
2 Average	2.178 MHz	36.93	L1	-9.06
2 Average	2.39 MHz	36.39	L1	-9.60
1 Quasi Peak	2.462 MHz	42.58	L1	-13.41
1 Quasi Peak	16.13 MHz	46.59	L1	-13.40
2 Average	16.13 MHz	43.17	L1	-6.82
1 Quasi Peak	24.746 MHz	42.57	L1	-17.42

**Tested Wire: Neutral**

**Operation Mode: on mode**

EDIT PEAK LIST (Final Measurement Results)				
Trace1:	CE1511QP			
Trace2:	CE1511AV			
Trace3:	---			
TRACE	FREQUENCY	LEVEL dBμV		DELTA LIMIT dB
1 Quasi Peak	166 kHz	45.70	L1	-19.45
2 Average	166 kHz	36.66	L1	-18.49
1 Quasi Peak	306 kHz	40.39	L1	-19.68
1 Quasi Peak	410 kHz	41.40	L1	-16.23
1 Quasi Peak	522 kHz	37.73	L1	-18.26
1 Quasi Peak	930 kHz	38.46	L1	-17.53
2 Average	2.114 MHz	34.10	L1	-11.89
1 Quasi Peak	2.174 MHz	41.94	L1	-14.05
2 Average	2.382 MHz	34.12	L1	-11.87
1 Quasi Peak	2.562 MHz	39.02	L1	-16.97
1 Quasi Peak	10.762 MHz	40.02	L1	-19.97
1 Quasi Peak	16.146 MHz	37.76	L1	-22.23
2 Average	16.146 MHz	26.68	L1	-23.31
1 Quasi Peak	24.586 MHz	41.44	L1	-18.55
2 Average	25.11 MHz	35.71	L1	-14.29

**At load/control terminal: Not Applicable**

Frequency [MHz]	Quasi-Peak		Average	
	Disturbance level [dB(μV)]	Permitted limit [dB(μV)]	Disturbance level [dB(μV)]	Permitted limit [dB(μV)]
--	--	--	--	--
--	--	--	--	--
--	--	--	--	--
--	--	--	--	--
--	--	--	--	--

**4.1.5 Emission Curve**  
**At mains terminal:**  
**Model: EIP016C1400LS**  
**Tested Wire: Live**

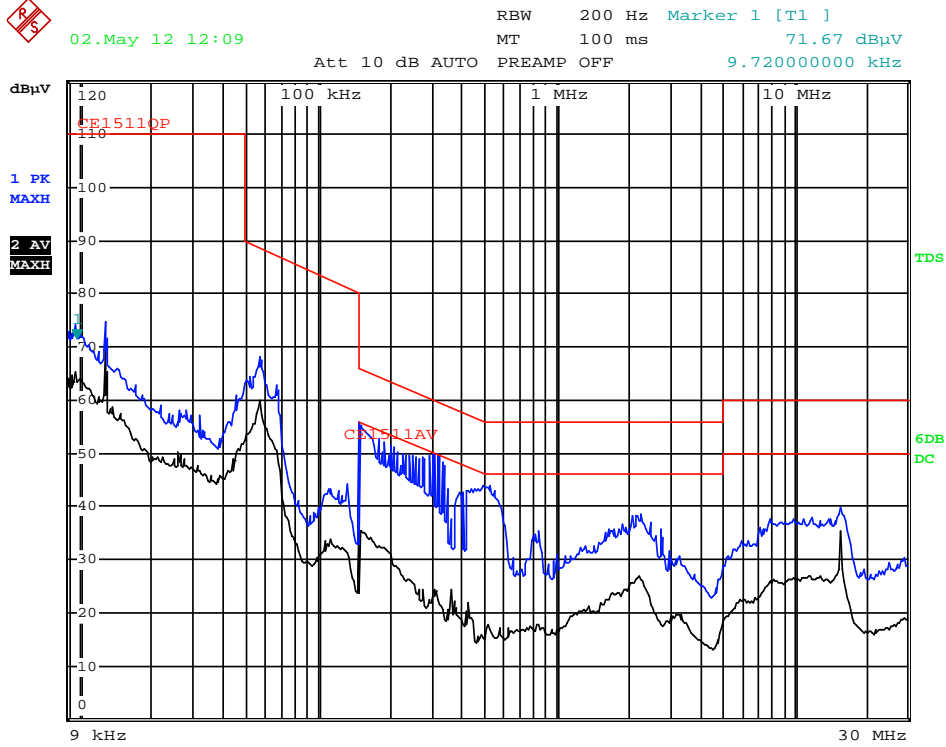

**Tested Wire: Neutral**

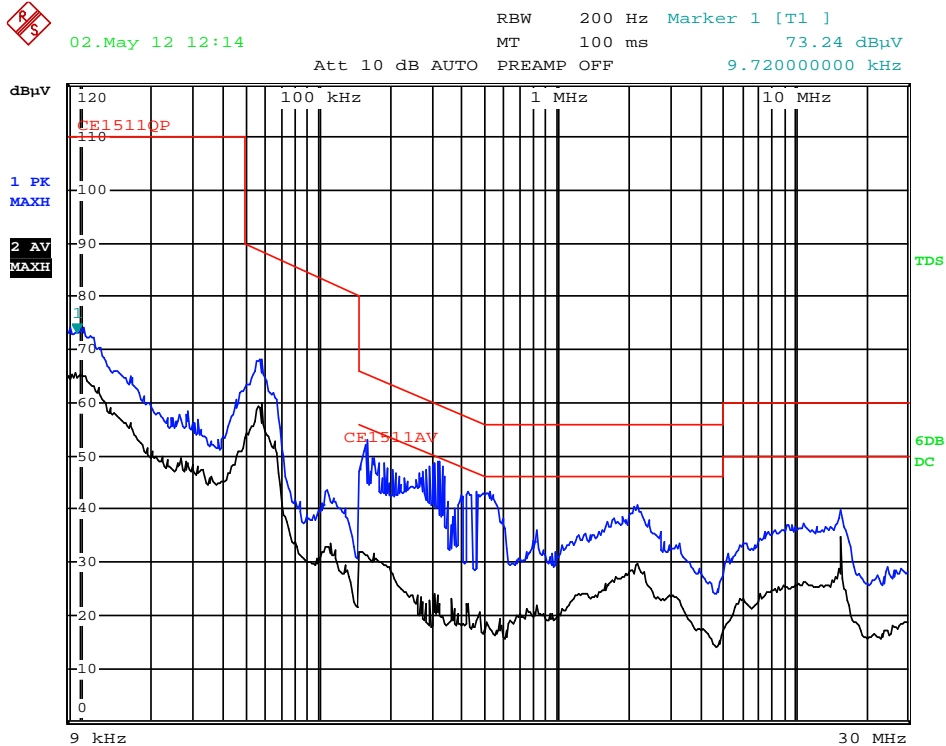



**Model: EIP016C0600LS**  
**Tested Wire: Live**

 02.May 12 13:24 RBW 9 kHz Marker 1 [T1 ]  
MT 1 s 66.35 dBµV  
Att 10 dB AUTO PREAMP OFF 9.80000000 kHz

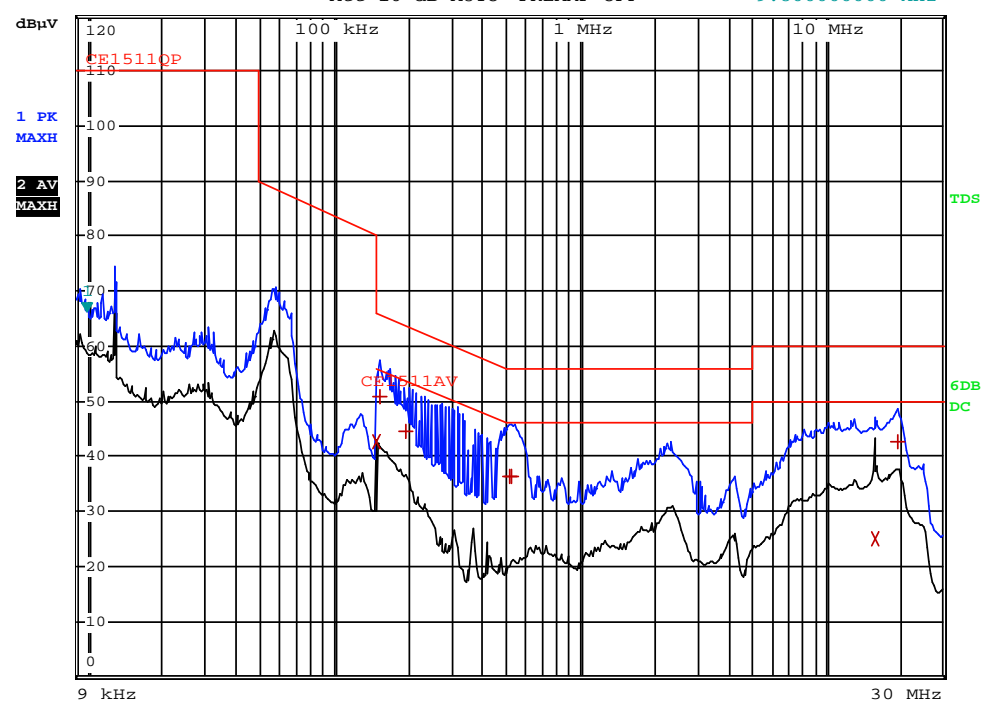

**Tested Wire: Neutral**

 02.May 12 13:30 RBW 9 kHz Marker 1 [T1 ]  
MT 1 s 70.84 dBµV  
Att 10 dB AUTO PREAMP OFF 9.80000000 kHz

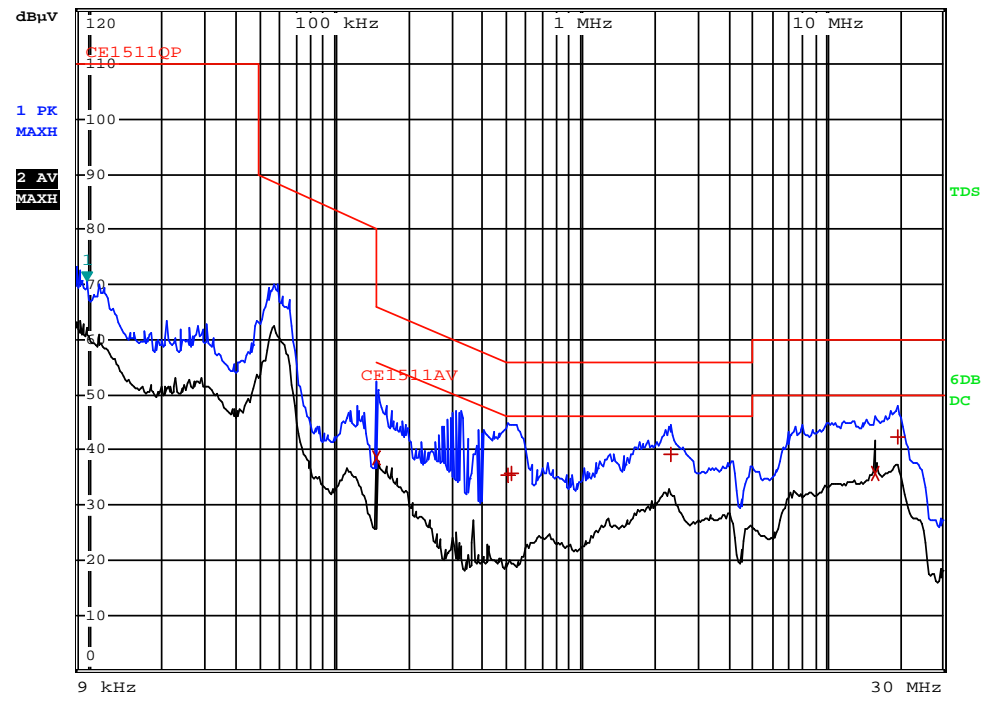





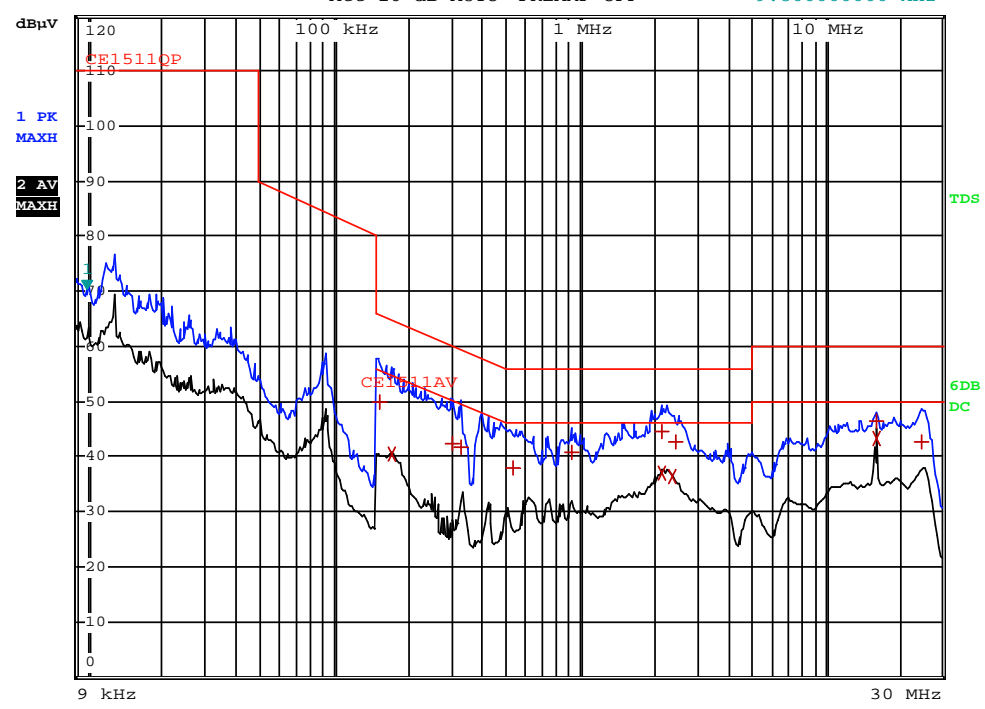

**Model: EIP016C0350LS**  
**Tested Wire: Live**

 02.May 12 13:13 RBW 9 kHz Marker 1 [T1 ]  
MT 1 s 70.31 dBuV  
Att 10 dB AUTO PREAMP OFF 9.80000000 kHz



**Tested Wire: Neutral**

 02.May 12 13:06 RBW 9 kHz Marker 1 [T1 ]  
MT 1 s 70.71 dBuV  
Att 10 dB AUTO PREAMP OFF 9.80000000 kHz

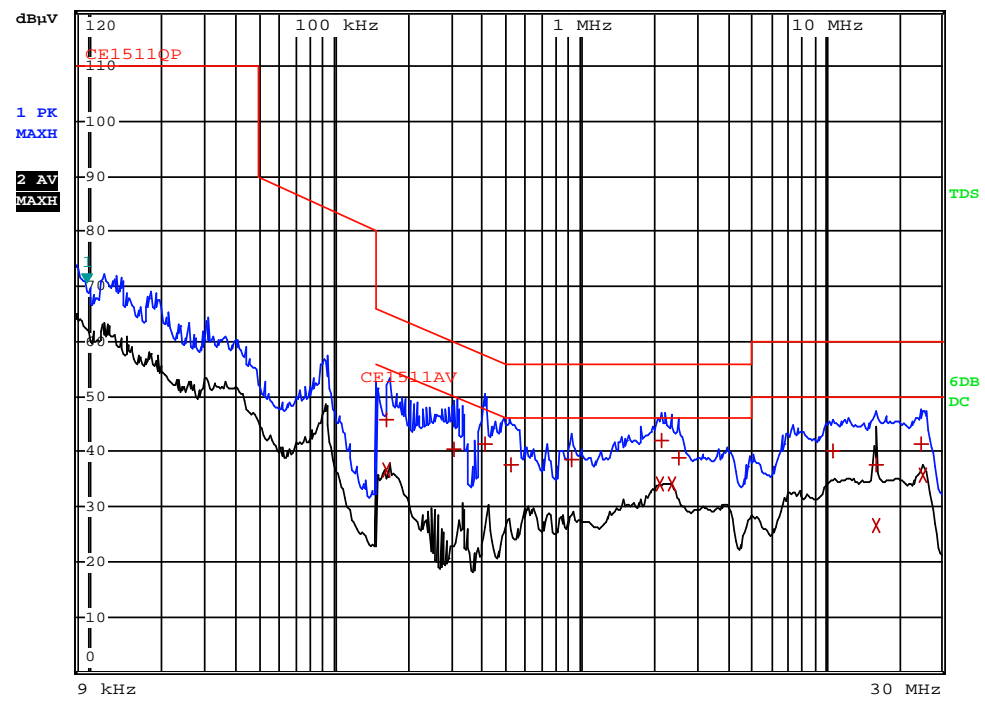

**At load/control terminal:**  
**Not Applicable.**

**4.1.6 Measurement Uncertainty**

The measurement uncertainty describes the overall uncertainty of the given measured value during the operation of the EUT.

Measurement uncertainty is calculated in accordance with CISPR 16-4-2: 2003.

Measurement uncertainty of mains terminal disturbance voltage in CISPR band A: 1.6 dB.

Measurement uncertainty of mains terminal disturbance voltage in CISPR band B: 2.3 dB.

The measurement uncertainty is given with a confidence of 95%, k=2.

**4.2 EN 55015 Radiated Electromagnetic Disturbance (9 kHz-30 MHz)**

**Test Result: Pass**

**4.2.1 Used Test Equipment**

Equipment No.	Equipment	Model	Manufacturer
EM080-05	EMI receiver	ESCI	R&S
EM061-04	Triple Loop Antenna	HXYZ9170	SCHWARZBECK
EM004-03	EMC shield Room	8m×4m×3m	Zhongyu

**4.2.2 Block Diagram of Test Setup**

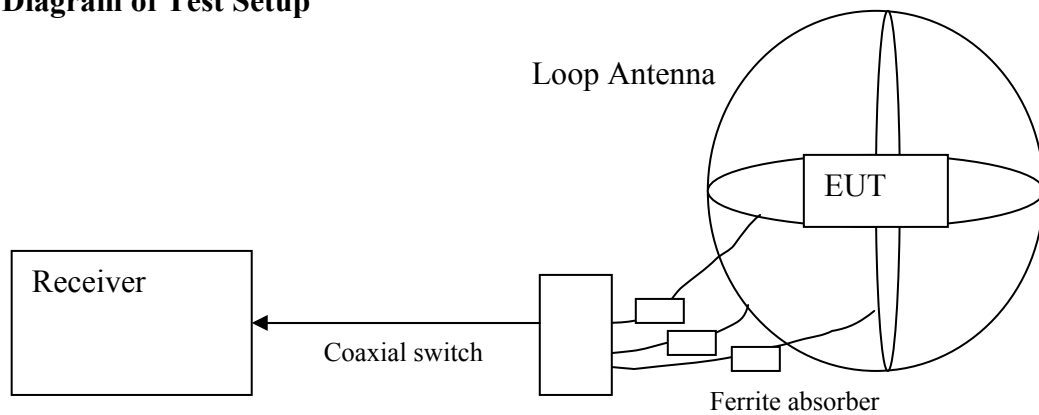

**4.2.3 Test Setup and Procedure**

The EUT is placed in the centre of the loop antenna system(LAS). The current induced by the magnetic field from the EUT into each of the three large loop antennas of the LAS is measured by connecting the current probe of the large loop antenna to a measuring receiver. During the measurements the EUT remains in a fixed position.

The currents in the three large loop antenna, origination from the three mutually orthogonal magnetic field components, are measured in sequence. Each current level measured shall comply with the emission limit, expressed in dBµA, as specified in table of EN 55015.

The distance between the outer perimeter of the LAS and nearby objects, such as floor and walls, shall be at least 0.5m.

To avoid unwanted capacitive coupling between the EUT and the LAS, the maximum dimensions of the EUT shall allow a distance of at least 0.2m between the EUT and the standardized 2m large loop antenna of the LAS.

The position of the mains lead shall be optimized for maximum current induction. In general, this position will not be critical when the EUT complies with the conducted emission limit.

#### 4.2.4 Test Data

Models: EIP016C1400LS, EIP016C0600LS, EIP016C0350LS

Frequency [MHz]	X axis [dB(μA)]	Y axis [dB(μA)]	Z axis [dB(μA)]	Limit [dB(μA)]
0.009	<78	<78	<78	88.0
0.050	<78	<78	<78	88.0
0.100	<64	<64	<64	74.0
0.160	<47	<47	<47	57.2
0.240	<40	<40	<40	52.4
0.550	<30	<30	<30	42.5
1.000	<25	<25	<25	35.4
1.400	<20	<20	<20	31.4
2.000	<17	<17	<17	27.1
3.500	<12	<12	<12	22.0
6.000	<12	<12	<12	22.0
10.000	<12	<12	<12	22.0
22.000	<12	<12	<12	22.0
30.000	<12	<12	<12	22.0



### 4.2.5 Test Curve

EIP016C1400LS

X axis

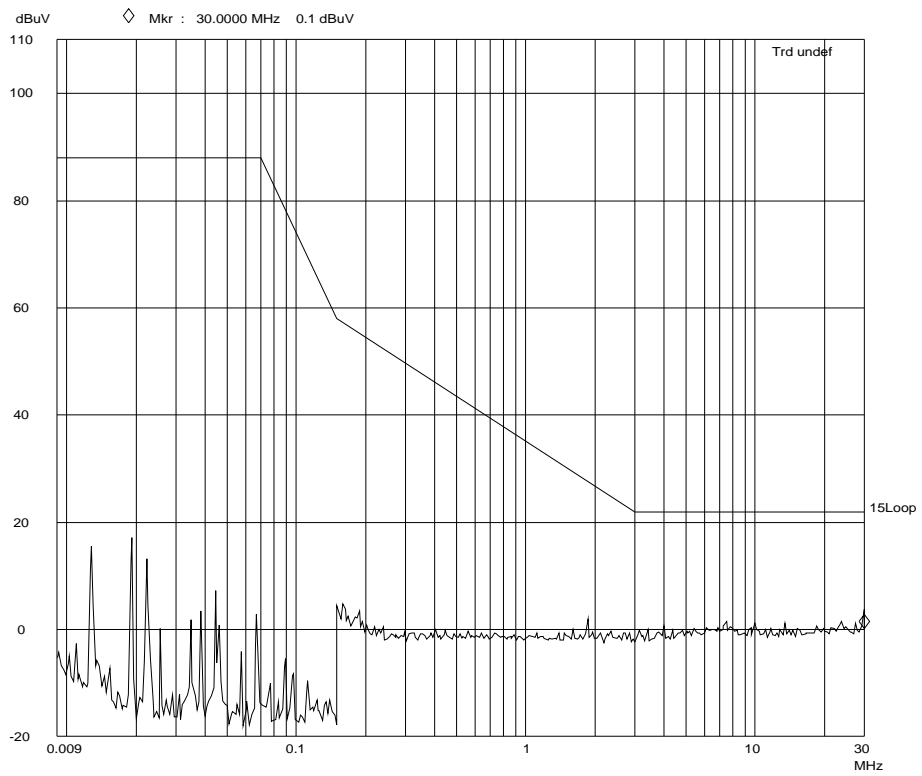

Y axis

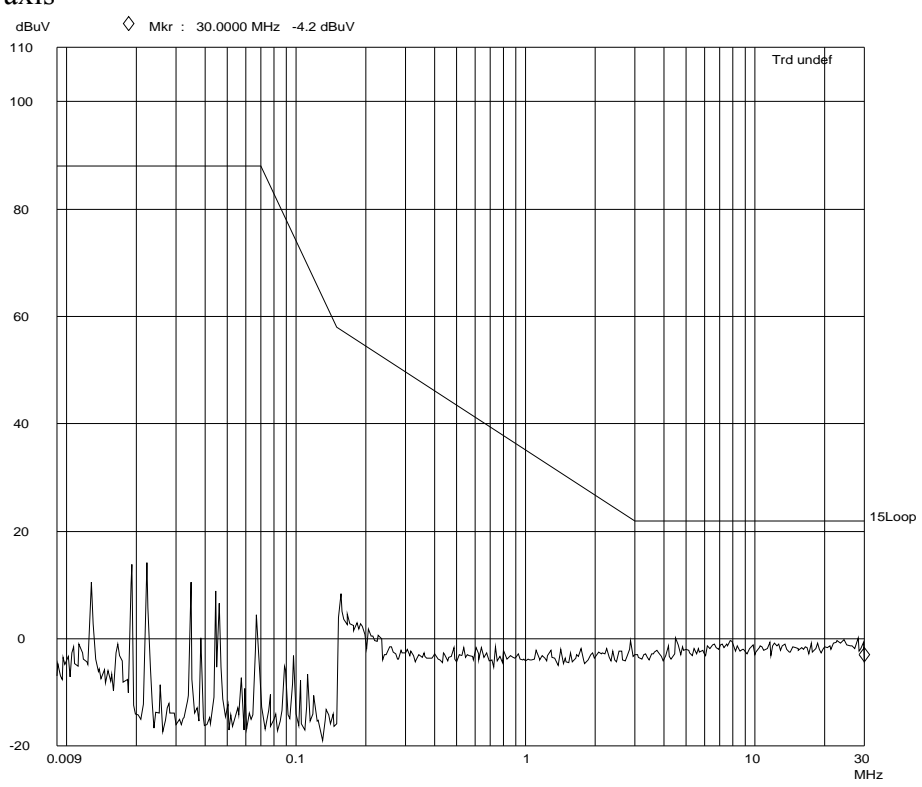

Z axis

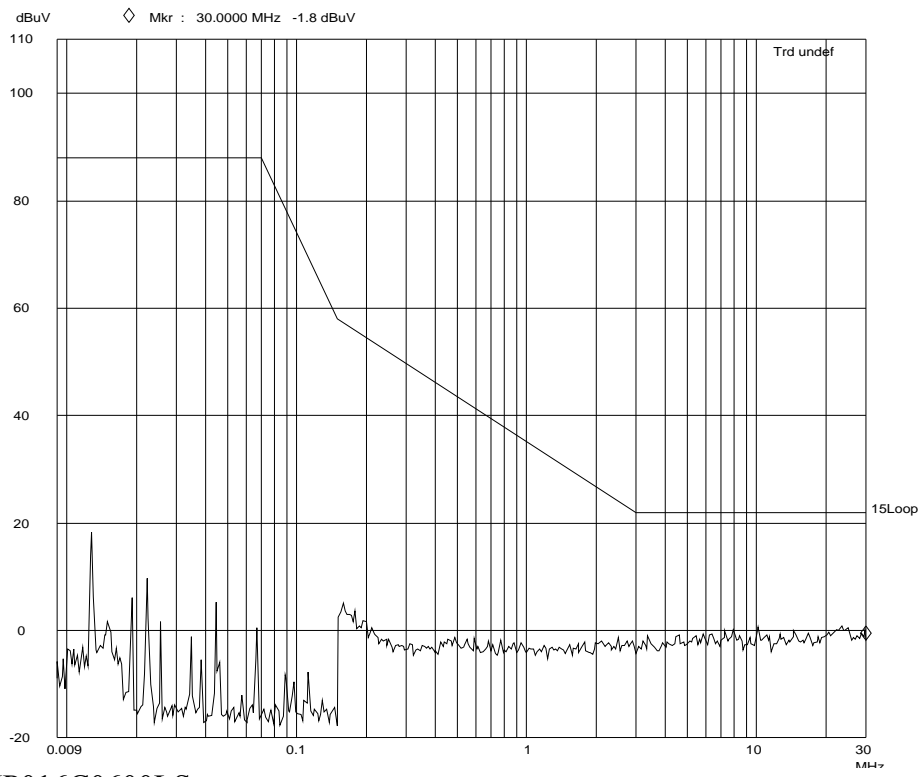

EIP016C0600LS

X axis

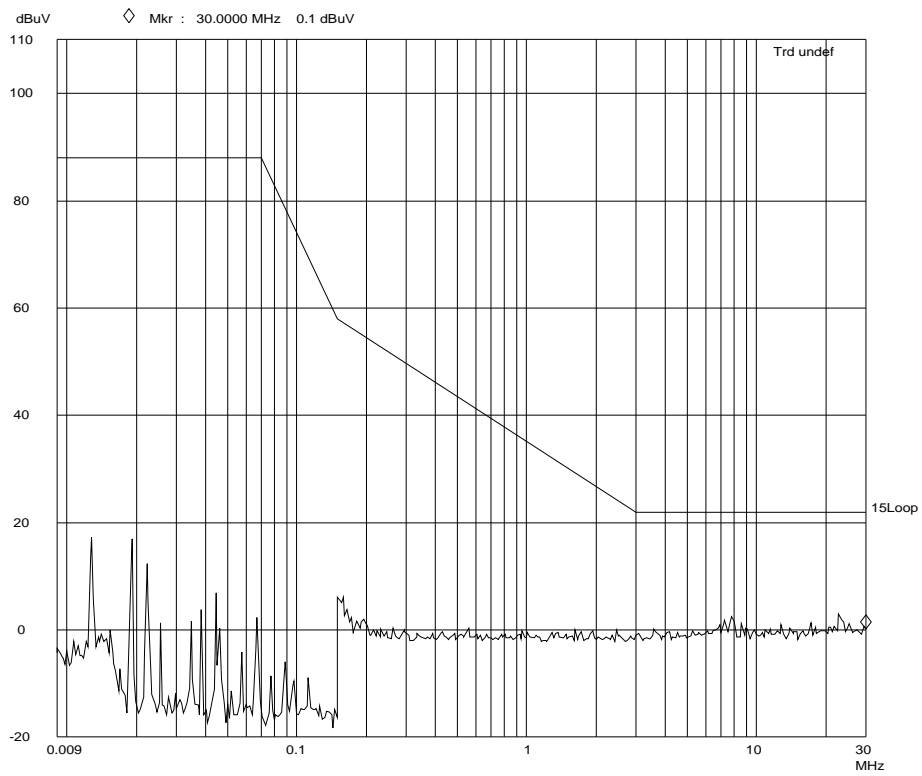

Y axis

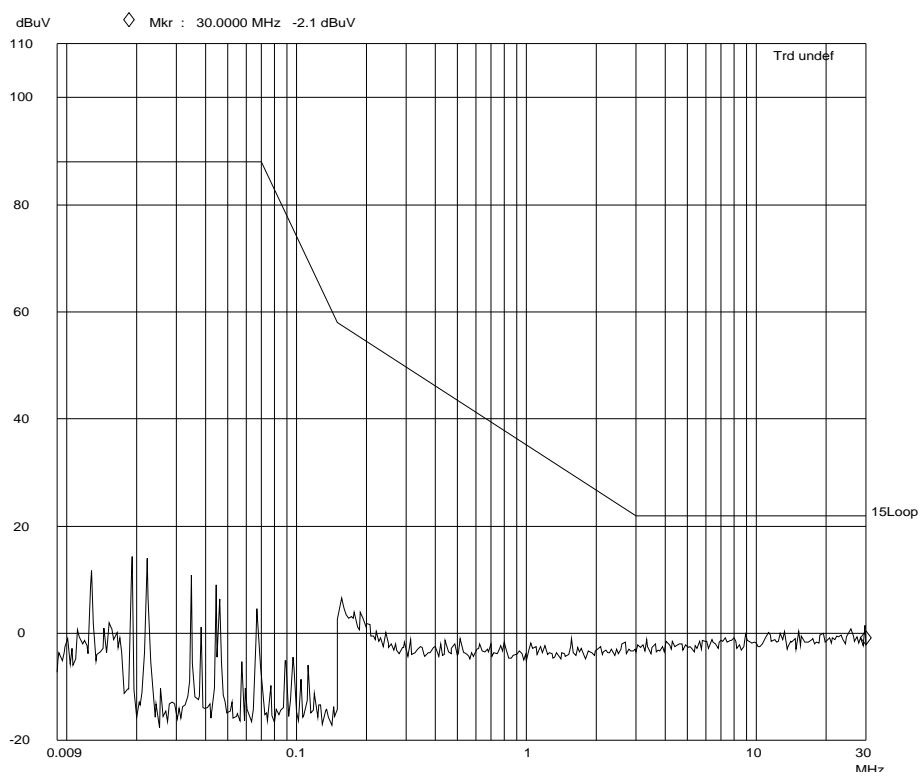

Z axis

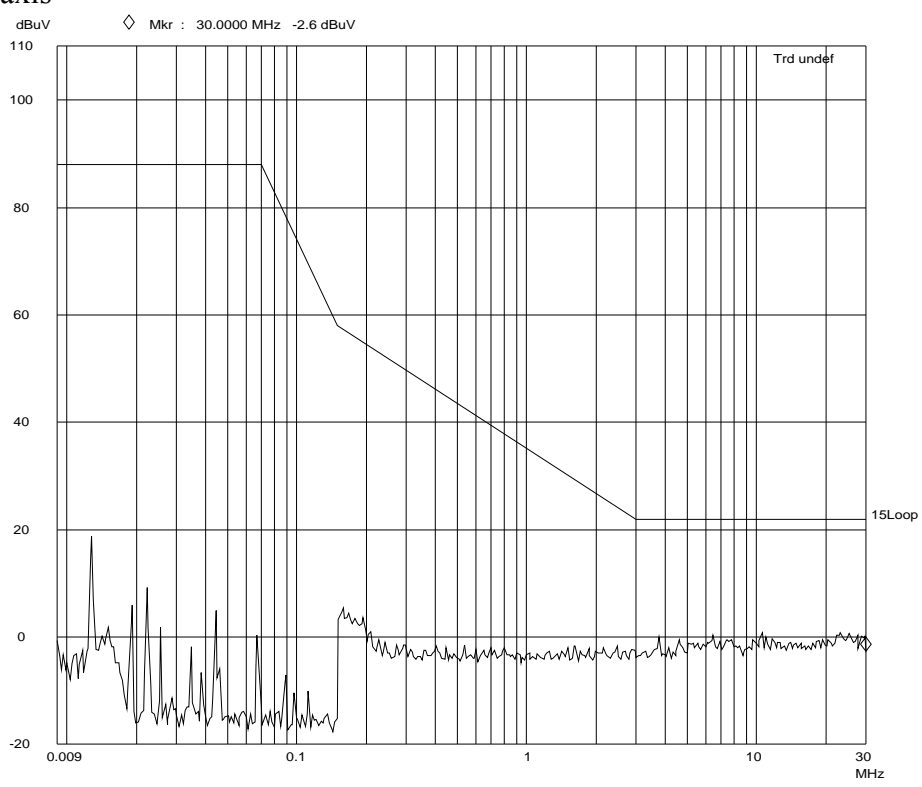

EIP016C0350LS

X axis

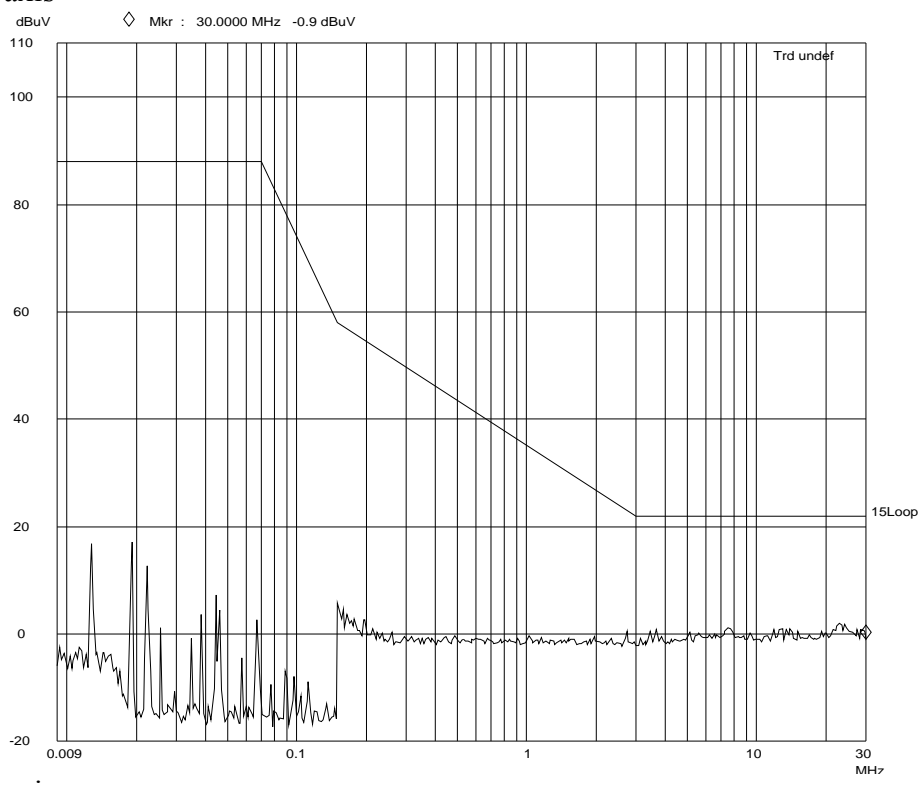

Y axis

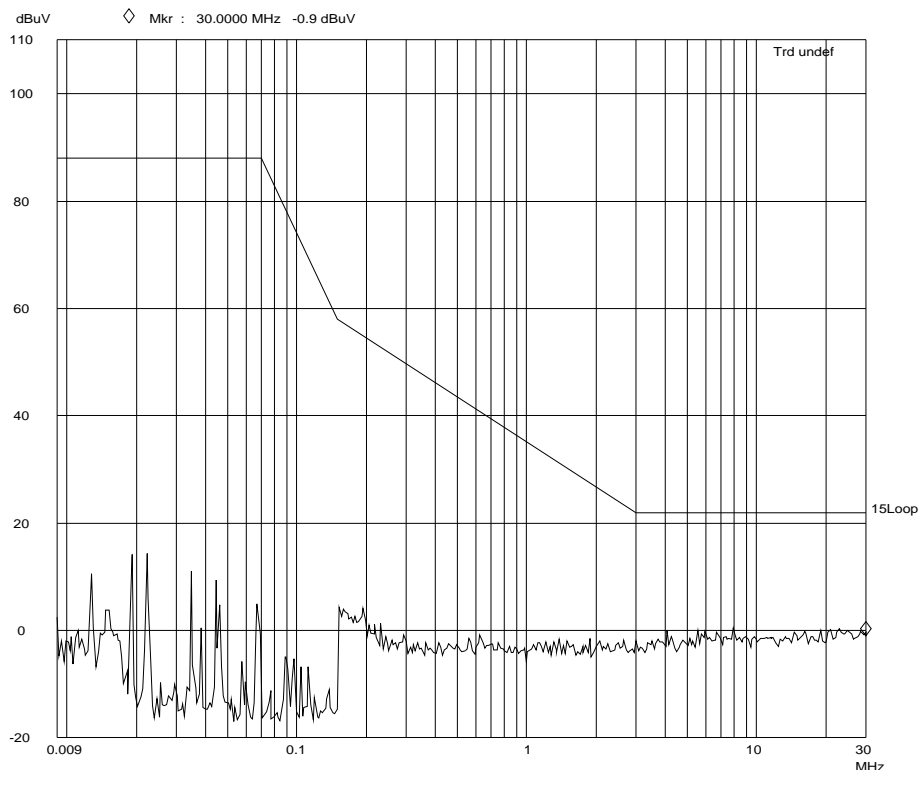

Z axis

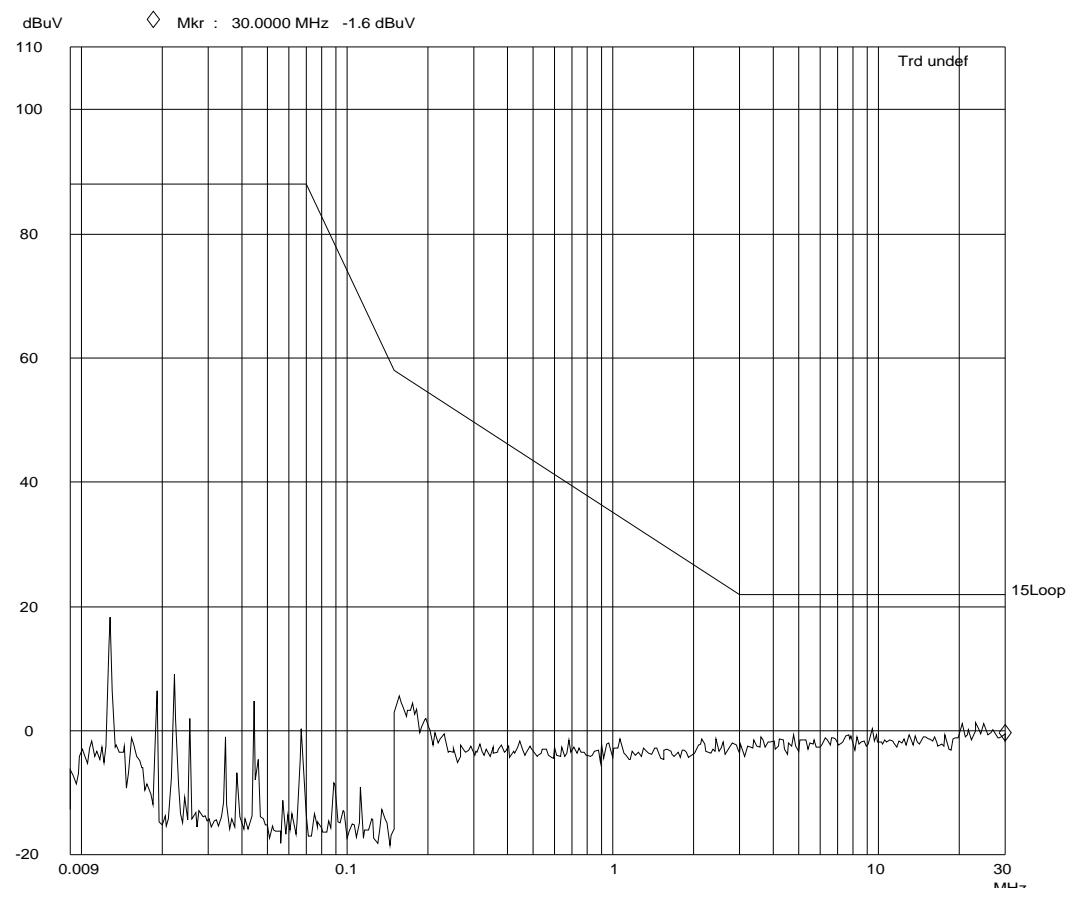

### 4.2.6 Measurement Uncertainty

The measurement uncertainty for induction current is under consideration according to CISPR 16-4-2:2003.



**4.3 EN 55015 Radiated Electromagnetic Disturbance (30 MHz -300 MHz, CDN method)  
Test Result: Pass**

**4.3.1 Used Test Equipment**

Equip. No.	Equipment	Model	Manufacturer
EM004-04	EMC shield Room	8m×3m×3m	Zhongyu
EM080-05	EMI receiver	ESCI	R&S
EM003-02	Coupling & Decoupling Network	CDN M2 16	TESEQ
EM003-01-05	Attenuator	6dB	drhubert

**4.3.2 Block Diagram of Test Setup**

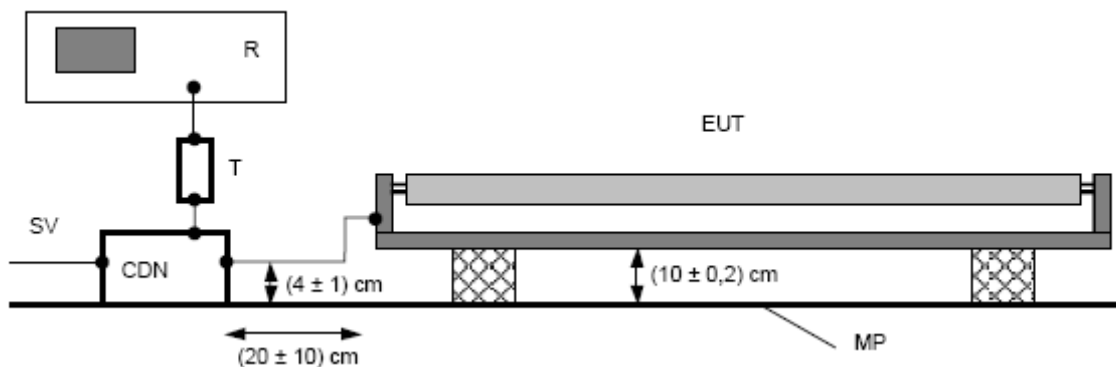

**4.3.3 Test Setup and Procedure**

The EUT shall be placed on a non-conducting table with a height of  $(10 \pm 0.2)$  cm.  
 The EUT is connected to CDN with a length of  $(20 \pm 10)$  cm and the distance of the cable to the metal plate should be  $(4 \pm 1)$  cm.  
 The RF output of the CDN is connected to EMI receiver via a 6 dB, 50Ω attenuator.  
 The distance from any conductive parts shall be more than 40 cm.

Prior to a measurement, the lamps shall be operated until stabilization has been reached.  
 5min for incandescent lamps, 15min for fluorescent lamp, 30min for other discharge lamp.

The EUT should be powered on before the coaxial cable is connected to receiver every time.  
 And the coaxial cable should be removed from receiver before stopping EUT.

### 4.3.4 Test Data

#### EIP016C1400LS

EDIT PEAK LIST (Final Measurement Results)				
Trace1:	15CDN			
Trace2:	---			
Trace3:	---			
TRACE	FREQUENCY	LEVEL dBμV		DELTA LIMIT dB
1 Quasi Peak	58.88 MHz	53.12	L1	-5.27
1 Quasi Peak	85.44 MHz	48.73	L1	-6.57
1 Quasi Peak	61.64 MHz	50.97	L1	-7.04
1 Quasi Peak	82.12 MHz	46.29	L1	-9.33
1 Quasi Peak	53.24 MHz	49.23	L1	-10.00
1 Quasi Peak	96.24 MHz	44.05	L1	-10.26

#### EIP016C0600LS

EDIT PEAK LIST (Final Measurement Results)				
Trace1:	15CDN			
Trace2:	---			
Trace3:	---			
TRACE	FREQUENCY	LEVEL dBμV		DELTA LIMIT dB
1 Quasi Peak	61.56 MHz	48.16	L1	-9.86
1 Quasi Peak	74 MHz	46.09	L1	-10.40
1 Quasi Peak	61.96 MHz	47.19	L1	-10.78
1 Quasi Peak	145.44 MHz	41.95	L1	-12.04
1 Quasi Peak	95.16 MHz	41.68	L1	-12.72
1 Quasi Peak	147.68 MHz	41.23	L1	-12.76
1 Quasi Peak	94.8 MHz	41.58	L1	-12.85
1 Quasi Peak	115 MHz	40.08	L1	-13.91
1 Quasi Peak	169 MHz	39.80	L1	-14.20
1 Quasi Peak	42.84 MHz	45.65	L1	-15.38
1 Quasi Peak	226.68 MHz	37.81	L1	-16.18
1 Quasi Peak	221.2 MHz	37.78	L1	-16.21

#### EIP016C0350LS

EDIT PEAK LIST (Final Measurement Results)				
Trace1:	15CDN			
Trace2:	---			
Trace3:	---			
TRACE	FREQUENCY	LEVEL dBμV		DELTA LIMIT dB
1 Quasi Peak	163.16 MHz	45.33	L1	-8.66
1 Quasi Peak	92.16 MHz	43.49	L1	-11.18
1 Quasi Peak	145.96 MHz	42.62	L1	-11.37
1 Quasi Peak	95.04 MHz	42.88	L1	-11.53
1 Quasi Peak	171.36 MHz	41.96	L1	-12.03
1 Quasi Peak	229.76 MHz	41.81	L1	-12.18
1 Quasi Peak	73.52 MHz	43.91	L1	-12.64
1 Quasi Peak	224.4 MHz	39.98	L1	-14.01
1 Quasi Peak	43.68 MHz	46.47	L1	-14.40
1 Quasi Peak	69.76 MHz	42.47	L1	-14.51



### 4.3.5 Test Curve EIP016C1600LS

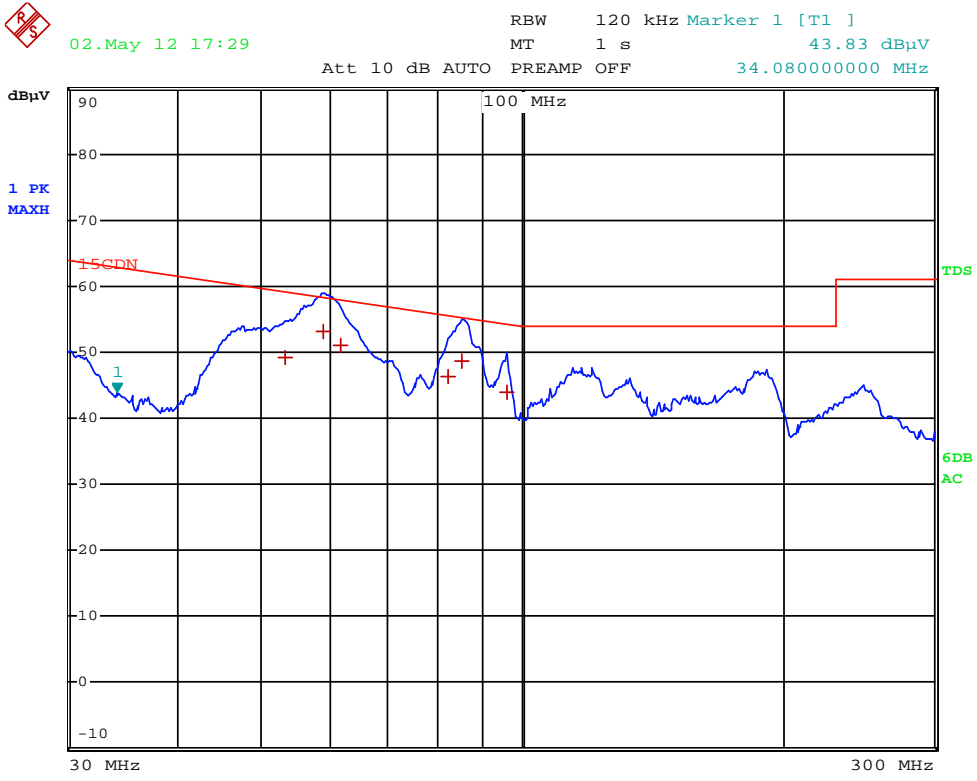

### EIP016C0600LS

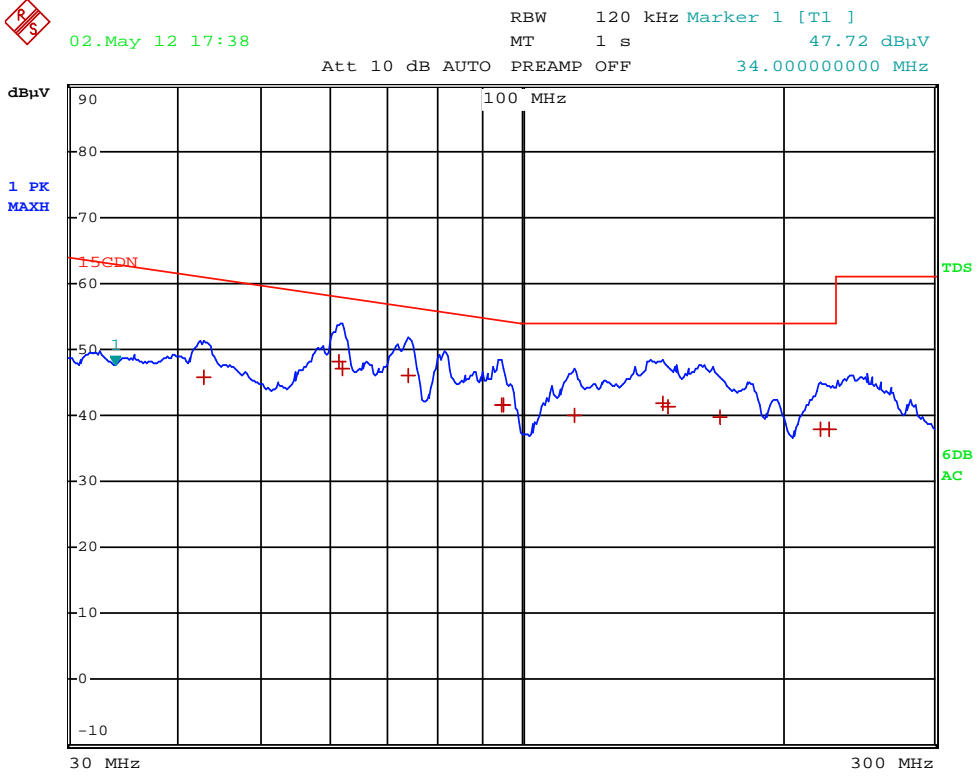

EIP016C0350LS

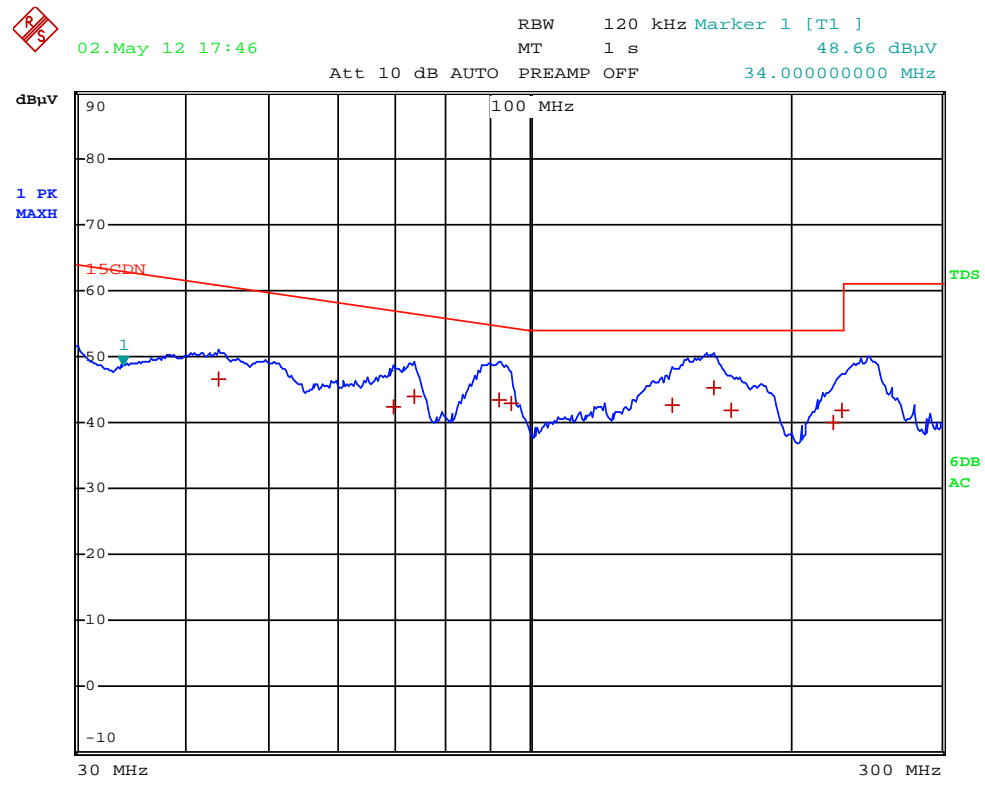

**4.3.6 Measurement uncertainty**

The measurement uncertainty for Radiated Electromagnetic Disturbance t (30 MHz -300 MHz, CDN method) is under consideration according to CISPR 16-4-2:2003.

**4.4 Insertion Loss**

**Test Result: Not Applicable.**  
**Remark: Not required by standard.**

**5 Harmonics of current**

**Test Result: Pass**

**5.1 Used Test Equipment**

Equipment No.	Equipment	Model	Manufacturer
EM001-02	Harmonic & Flicker Test System	5001IX-CTS-400-413	California Instrument

**5.2 Block Diagram of Test Setup**

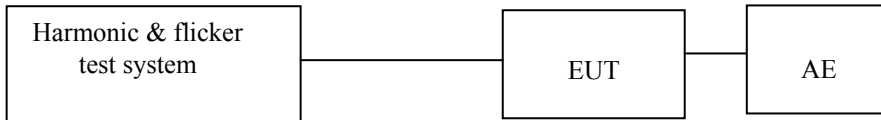

**5.3 Test Setup and Procedure**

EUT is not discharge lighting, the harmonics currents limits are not specified for the equipment with a rated power smaller than or equal to 25W. Therefore the EUT was deemed fulfill the requirements of relative standard without testing.

## 6 Flicker

**Test Result: Pass**

### 6.1 Used Test Equipment

Equipment No.	Equipment	Model	Manufacturer
EM001-02	Harmonic & Flicker Test System	5001IX-CTS-400-413	California Instrument

### 6.2 Block Diagram of Test Setup

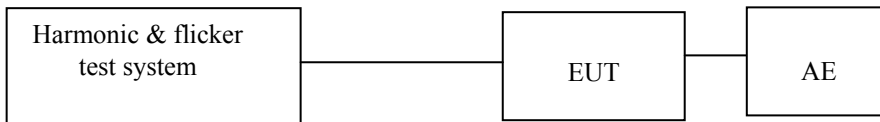

### 6.3 Test Setup and Procedure

#### 6.3.1 Definition

- Flicker: impression of unsteadiness of visual sensation induced by a lighting stimulus whose luminance or spectral distribution fluctuates with time.
- Pst: Short-term flicker indicator The flicker severity evaluated over a short period (in minutes); Pst=1 is the conventional threshold of irritability
- Plt: long-term flicker indicator; the flicker severity evaluated over a long period (a few hours). Using successive Pst value.
- dc: the relative steady-state voltage change
- dmax: the maximum relative voltage change
- d(t): the value during a voltage change

#### 6.3.2 Test condition

The EUT is unlikely to produce significant voltage fluctuations or flicker, so no flicker tests need be made on the EUT.

## EMS TEST

**Performance Criteria:**

- Criterion A: During the test no change of the luminous intensity shall be observed and the regulating control, if any, shall operate during the test as intended.
- Criterion B: During the test the luminous intensity may change to any value. After the test the luminous intensity shall be restored to its initial value within 1 min.  
Regulating controls need not function during the test, but after the test the mode of the control shall be the same as before the test provided that during the test no mode changing commands were given.
- Criterion C: During and after the test any change of the luminous intensity is allowed and the lamp(s) may be extinguished. After the test, within 30 min, all functions shall return to normal if necessary by temporary interruption of the mains supply and /or operating the regulating control.  
Additional requirement for lighting equipment incorporation a starting device:  
After the test the lighting equipment is switched off. After half an hour it is witched on again. The lighting equipment shall start and operate as intended.

**Measurement Uncertainty**

According to CISPR 16-4-2:2003, measurement uncertainty to immunity test is under consideration.

*Note: "N/A" means Not Applicable in below text.*

**6.1 EN 61000-4-2(Pursuant to EN 61547) Electrostatic Discharge Immunity**

**Performance criterion: B**

**Test Result: Pass**

**6.1.1 Used Test Equipment**

Equip. No.	Equipment	Model	Manufacturer
EM077-02	ESD Simulator	NSG435	SCHAFFNER

### 6.1.2 Block Diagram of Test Setup

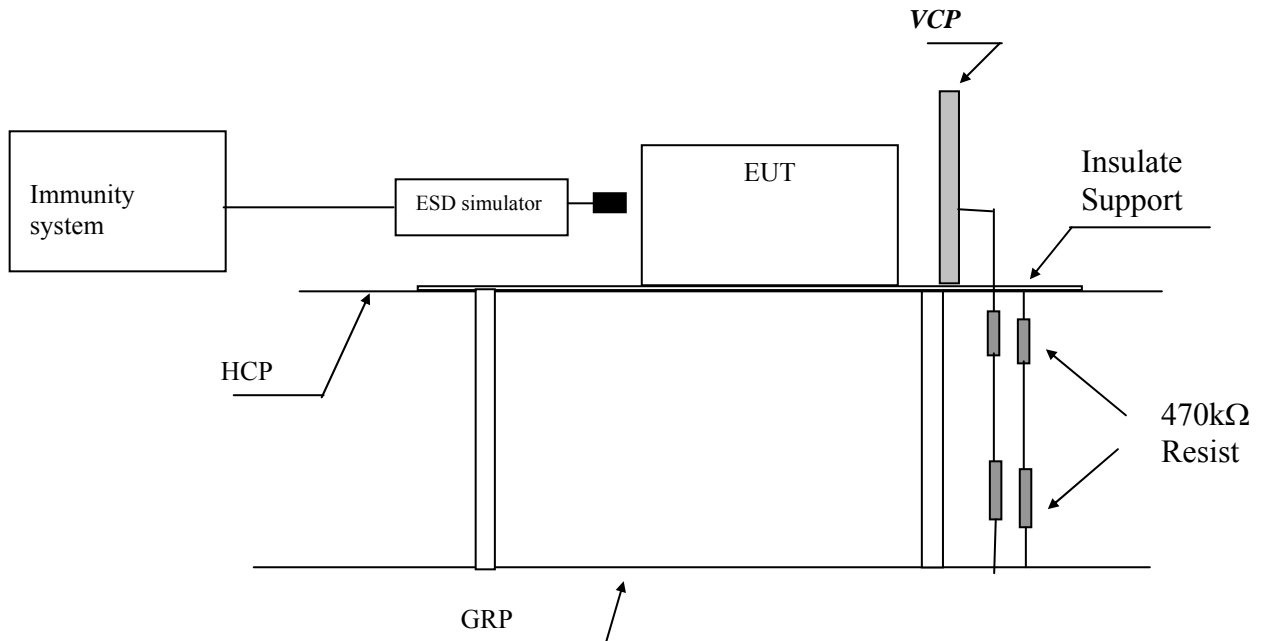

Note: HCP means Horizontal Coupling Plane,  
 VCP means Vertical Coupling Plane  
 GRP means Ground Reference Plane

### 6.1.3 Test Setup and Procedure

The EUT was put on a  $(0,8 \pm 0,08)$  m high wooden table/0.1m high for floor standing equipment standing on the ground reference plane (GRP) 3m by 2m in size, made by iron 1.0 mm thick. A horizontal coupling plane (HCP)  $(1,6 \pm 0,02)$  m by  $(0,8 \pm 0,02)$  m in size was placed on the table, and the EUT with its cables were isolated from the HCP by an insulating support with  $(0,5 \pm 0,05)$  mm thick. The VCP 0.5m by 0.5m in size & HCP were constructed from the same material type & thickness as that of the GRP, and connected to the GRP via a 470kΩ resistor at each end.

For floor standing equipment, The EUT shall be isolated from the ground reference plane by an insulating support of 0,05 m to 0,15 m thick. The EUT cables shall be isolated from the ground reference plane by an insulating support of  $(0,5 \pm 0,05)$  mm. This cable isolation shall extend beyond the edge of the EUT isolation.

The distance between EUT and any of the other metallic surface excepted the GRP, HCP & VCP was greater than 0.8m.

The EUT was arranged and connected according to its functional requirements.

Direct static electricity discharges was applied only to those points and surface which are accessible to personnel during normal usage, terminals are excluded.

On each preselected points 10 times of each polarity single discharge were applied .



The ESD generator was held perpendicular to the surface to which the discharge is applied.

The discharge return cable of the generator was kept at a distance of 0.2m whilst the discharge is being applied. During the contact discharges, the tip of the discharge electrode was touch the EUT before the discharge switch is operated. During the air discharges, the round discharge tip of the discharge electrode was approached as fast as possible to touch the EUT.

Indirect discharge was conducted to objects placed near the EUT, simulated by applying the discharges of the ESD generator to a coupling plane, in the contact discharge mode.

After each discharge, the ESD generator was removed from the EUT, the generator is then retriggered for a new single discharge. For ungrounded product, a grounded carbon fibre brush with bleeder resistors ( $2 \times 470 \text{ k}\Omega$ ) in the grounding cable was used after each discharge to remove remnant electrostatic voltage.

10 times of each polarity single discharge were applied to HCP and VCP. The detail selected points are listed in the following table.

### 6.1.4 Test Result

#### Direct Application of ESD

##### Direct Contact Discharge

Applied Voltage (kV)	No. of Discharge for each point	Result (Pursuant to EN 61547)	Discharged Points
4	20	Pass	Accessible metal parts of the EUT.

##### Direct Air Discharge

Applied Voltage (kV)	No. of Discharge for each point	Result (Pursuant to EN 61547)	Discharged Points
2, 4, 8	20	Pass	All accessible points where contact discharge cannot be applied such as Air gap

#### Indirect Application of ESD

##### Horizontal Coupling Plane under the EUT

Applied Voltage (kV)	No. of Discharge for each point	Result (pursuant to EN 61547)	Discharged Point
4	20	Pass	At the front edge of each HCP opposite the centre point of each unit of the EUT

##### Vertical Coupling Plane beside the EUT

Applied Voltage (kV)	No. of Discharge for each point	Result (pursuant to EN 61547 criterion B)	Discharged Point
4	20	Pass	The centre of the vertical edge of the coupling plane

## 6.2 EN 61000-4-6(Pursuant to EN 61547) Injected Current (0.15 MHz to 80 MHz)

**Performance criterion: A**

**Test Result: Pass**

### 6.2.1 Used Test Equipment

Equip. No.	Equipment	Model	Manufacturer
EM019-01	Conducted Immunity Testing System	NSG4070-75	Teseq GmbH
EM019-01-02	Coupling & Decoupling Network	CDNM016	Teseq GmbH
EM019-01-03	6dB Attenuator	ATN6075	Teseq GmbH

### 6.2.2 Block Diagram of Test Setup

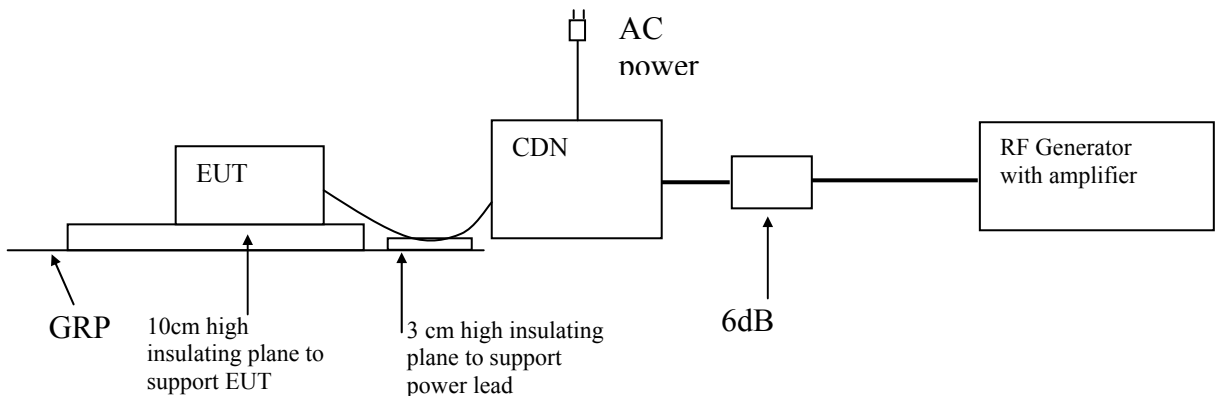

### 6.2.3 Test Setup and Procedure

The EUT was placed on an insulating support of 0.1m height above a ground reference Plane, arranged and connected to satisfy its functional requirement.

All relevant cables were provided with the appropriate coupling and decoupling devices at a distance between 0.1m and 0.3m from the projected geometry of the EUT on an insulating support of 0.03m height above the ground reference plane.

Test voltage was verified before each testing through power meter combined in the RF generator with AMP.

Dwell time was set to 3s and step was set as 1% to keep sufficient response time for EUT.

The frequency from 0.15MHz to 80MHz was checked.

**6.2.4 Test Result**

Port:	Frequency (MHz)	Level (Pursuant to EN 61547)	Result
A.C. Power Lines	0.15 to 80	3V (r.m.s.)	Pass
D.C. Power Lines	0.15 to 80	3V (r.m.s.)	N/A
Signal Lines	0.15 to 80	3V (r.m.s.)	N/A
Control Lines	0.15 to 80	3V (r.m.s.)	N/A

**6.3 EN 61000-4-4(Pursuant to EN 61547) Electrical Fast Transient/Burst**

**Performance criterion: B**

**Test Result: Pass**

**6.3.1 Used Test Equipment**

Equipment No.	Equipment	Model	Manufacturer
EM005-07	EMS test system	Ecompact 4	HAEFELY

**6.3.2 Block Diagram of Test Setup**

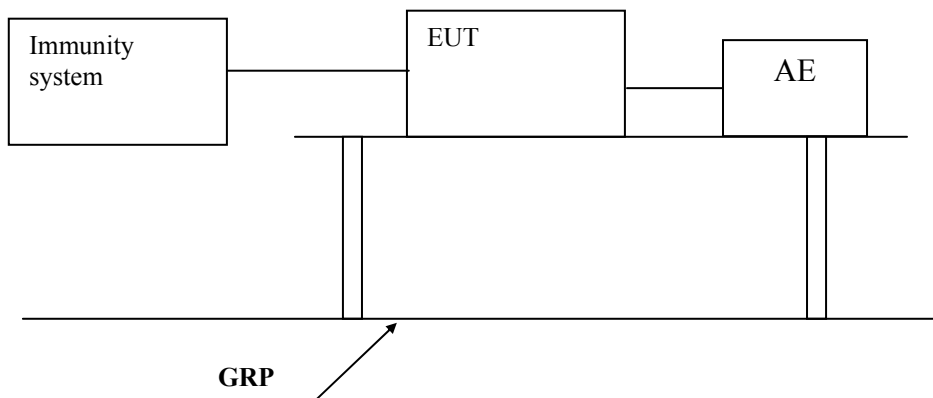

### 6.3.3 Test Setup and Procedure

The EUT was placed on a 0.1m high wooden table, standing on the ground reference plane 3m by 2m in size, made by steel 1mm thick.

The distance between the EUT and any other of the metallic surface except the GRP is greater than 0.5m.

The mains lead excess than 0.5m is folded to avoid a flat coil and situated at a distance of 0.1m above the ground reference plane to insure the distance between the coupling device and the EUT were 0.5m.

The EUT was arranged and connected to satisfy its functional requirement and supplied by the coupling-decoupling network.

### 6.3.4 Test Result

Level (Pursuant to EN 61547)	Polarity	Input and Output A.C. Power Ports	D.C. Power Ports, Signal and Control Lines
0.5kV	+	N/A	N/A
0.5kV	-	N/A	N/A
1kV	+	Pass	N/A
1kV	-	Pass	N/A

**6.4 EN 61000-4-5(Pursuant to EN 61547) Surge Immunity**

Performance criterion:  C

B (luminaire for emergency lighting)

Test Result: Pass

**6.4.1 Used Test Equipment**

Equipment No.	Equipment	Model	Manufacturer
EM005-09	Surge/DIP Generator	NSG3040	TESEQ

**6.4.2 Block Diagram of Test Setup**

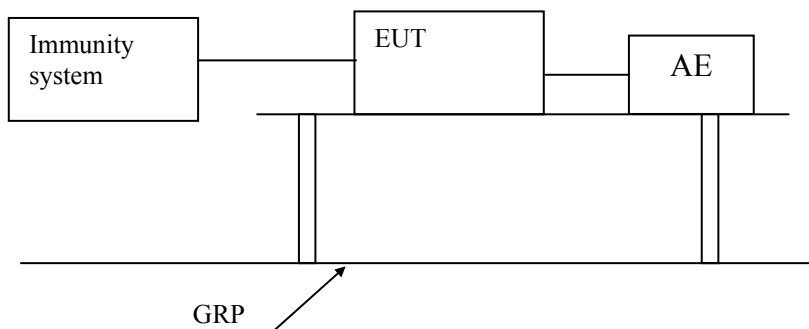

**6.4.3 Test Setup and Procedure**

The surge is to be applied to the EUT power supply terminals via the capacitive coupling network.

Decoupling networks are required in order to avoid possible adverse effects on equipment not under test that may be powered by the same lines and to provide sufficient decoupling impedance to the surge wave so that the specified wave may be developed on the lines under test.

The EUT was arranged and connected according to its functional requirements.

The EUT was placed on a 0.1m high wooden support above the GRP), supplied by the coupling-decoupling network, and arranged and connected to satisfy its functional requirement. The power cord between the EUT and the coupling/decoupling network was less than 2 meters.

Five positive and five negative pulses shall be applied at the peak value and zero crossing points of the a.c. voltage wave.

**6.4.4 Test Result**

I. For Self-ballasted lamps and semi-luminaires and independent auxiliaries with input power less or equal to 25 W:

Level (Pursuant to EN 61547)	Result
Between Phase And Phase: 0.5 kV	N/A
Between Phase And Neutral: 0.5 kV	Pass
Between Phase And Earth: 0.5 kV, 1.0 kV	N/A
Between Neutral And Earth: 0.5 kV, 1.0 kV	N/A

II. For luminaires and independent auxiliaries with input power greater than 25 W:

Level (Pursuant to EN 61547)	Result
Between Phase And Phase: 0.5 kV, 1.0 kV	N/A
Between Phase And Neutral: 0.5 kV, 1.0 kV	N/A
Between Phase And Earth: 0.5 kV, 1.0 kV, 2.0 kV	N/A
Between Neutral And Earth: 0.5 kV, 1.0 kV, 2.0 kV	N/A

**6.5 EN 61000-4-11(Pursuant to EN 61547) Voltage Dips and Interruptions**

**Performance criterion:**

for table 11 of EN 61547 ----- C

for table 12 of EN 61547----- B

**Test Result: Pass**

**6.5.1 Used Test Equipment**

Equipment No.	Equipment	Model	Manufacturer
EM005-07	EMS test system	Ecompact 4	HAEFELY

**6.5.2 Block Diagram of Test Setup**

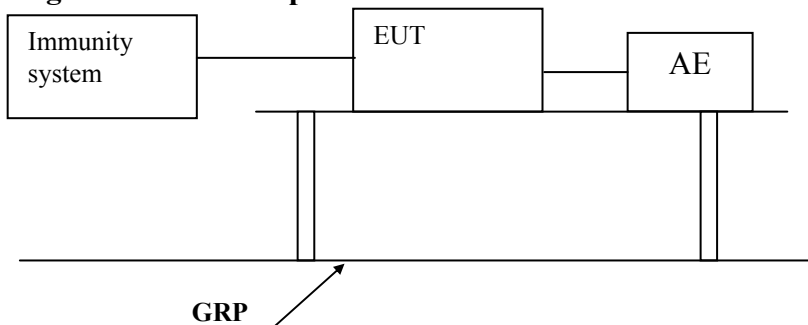

### 6.5.3 Test Setup and Procedure

The EUT was placed on an insulating support of 0.8m height, standing on a ground reference plane, and arranged and connected to satisfy its functional requirement

The test was performed with the EUT connected to the test generator with the shortest power supply cable as specified by the EUT manufacturer.

The EUT was tested for each selected combination of test level and duration with a sequence of three dips/interruptions with intervals of 10 s minimum. Each representative mode of operation was tested.

EUT is tested for voltage reduction of 0% $U_T$ , 0.5 period, 70% $U_T$ , 10 periods, both the positive and negative polarity test was conducted.

Changes to the voltage level shall occur at a zero crossing point in the a.c. voltage waveform.

### 6.5.4 Test Result

I. According to table 11 of EN 61547

Test condition (Pursuant to EN 61547)		Result
Test Level in % $U_T$	Duration (in period of the rated frequency)	
70	10	Pass

II. According to table 12 of EN 61547

Test condition (Pursuant to EN 61547)		Result
Test Level in % $U_T$	Duration (in period of the rated frequency)	
0	0.5	Pass

Remark:  $U_T$  is the rated voltage for the equipment.



**6.6 EN 61000-4-3(Pursuant to EN 61547) Radiated Electromagnetic Field Immunity**

**Performance criterion: A**

**Test Result: Pass**

**6.6.1 Used Test Equipment**

Equipment No.	Equipment	Model	Manufacturer
SB3433	Signal Generator	SMT03	R&S
SB3437/01	Voltage Probe	URV5-Z2	R&S
SB3173	Power Amplifier	150W100	AR
SB3938	Power Amplifier	25S1G4AM1	AR
SB2622	Bilog Antenna	CBL6111C	Chase
SB3450/02	FAC	MCDC	Albatross Pro.
-----	Power Meter	NRVS	R&S

**6.6.2 Block Diagram of Test Setup**

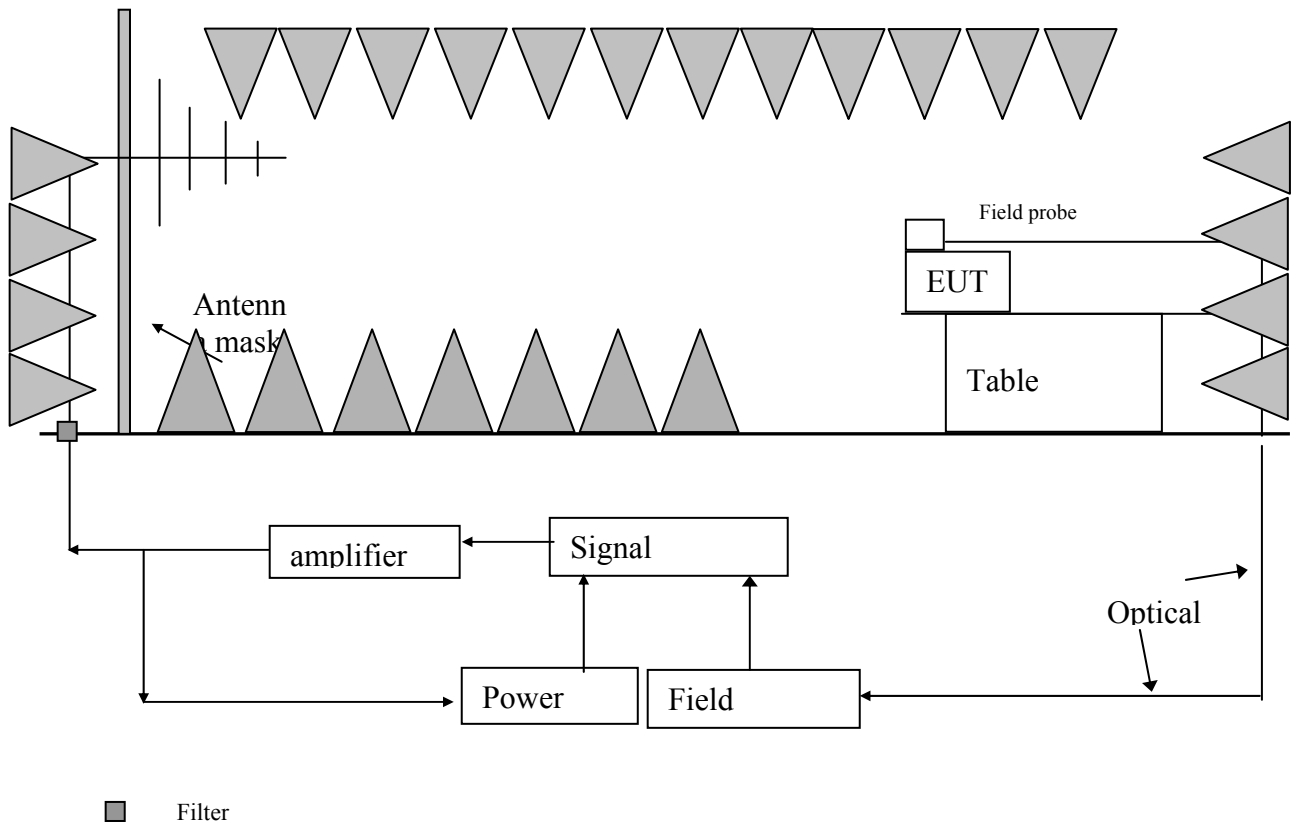

**6.6.3 Test Setup and Procedure**

The test was conducted in an fully anechoic chamber to maintain a uniform field of sufficient dimensions with respect to the EUT, and also in order to comply with various national and international laws prohibiting interference to radio communications.

The equipment is placed in the test facility on a non-conducting table 0.8m high (for floor standing EUT, is placed on a non-conducting support 0.1m height).

The EUT was placed on the uniform calibrated plane which is 3V/m EM field.

For all ports connected to EUT, manufacturer specified cable type and length was used, for those cables no specification, unshielded cable applied.

Wire is left exposed to the electromagnetic field for a distance of 1m from the EUT.

The EUT was arranged and connected according to its functional requirements

Before testing, the intensity of the established field strength have been checked by placing the field sensor at a calibration grid point, and with the field generating antenna and cables in the same positions as used for the calibration, the forward power needed to give the calibrated field strength was measured.

Spot checks was made at a number of calibration grid points over the frequency range 80MHz to 1000MHz, both polarizations was checked.

After calibration, the EUT is initially placed with one face coincident with the calibration plane.

The frequency range is swept from 80MHz to 1000MHz, with the signal 80% amplitude modulated with a 1 kHz sinewave, pausing to adjust the r.f. signal level.

The dwell time at each frequency was 3s so as that the EUT to be exercised and be able to respond.

The step size was 1% of the fundamental with linear interpolation between calibrated points. Test was performed with the generating antenna facing each of the four sides of the EUT.

**6.6.4 Test Result**

Frequency (MHz)	Exposed Side	Field Strength (V/m)	Result
80 to 1000	Front	3V/m (r.m.s.)	Pass
80 to 1000	Left	3V/m (r.m.s.)	Pass
80 to 1000	Rear	3V/m (r.m.s.)	Pass
80 to 1000	Right	3V/m (r.m.s.)	Pass

**6.7 EN 61000-4-8(Pursuant to EN 61547) Power Frequency Magnetic Field Immunity**

**Performance criterion: A**

**Test Result: Not Applicable**

**Remark:**

Equipment containing no Hall elements or magnetic field sensors is not susceptible to magnetic field. Hence, this equipment is deemed to fulfil the magnetic field test.

**7 Appendix I - Photos of test setup**

Conducted Emission

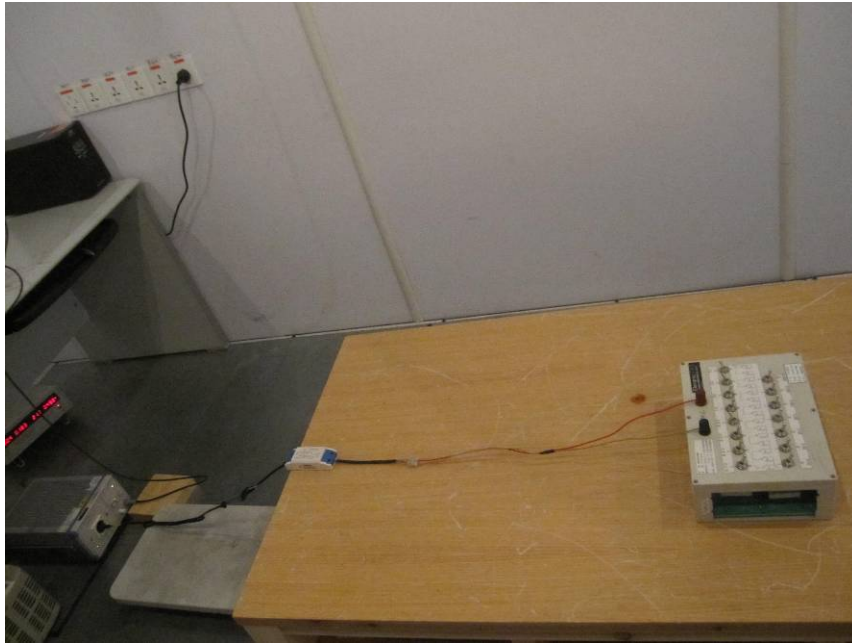

Radiated Electromagnetic Filed Disturbance



Radiated Emission (CDN method)



ESD Immunity

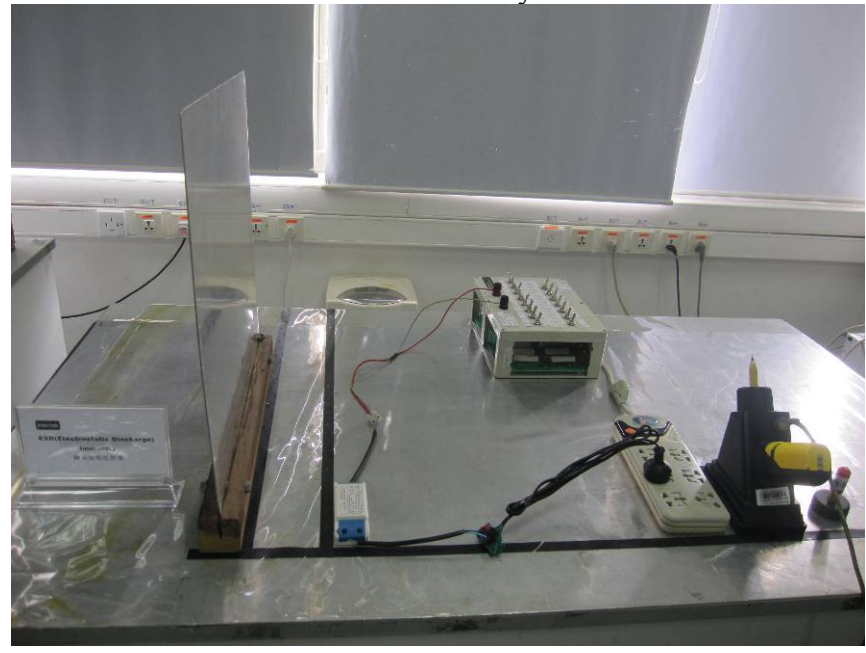

Surge Immunity

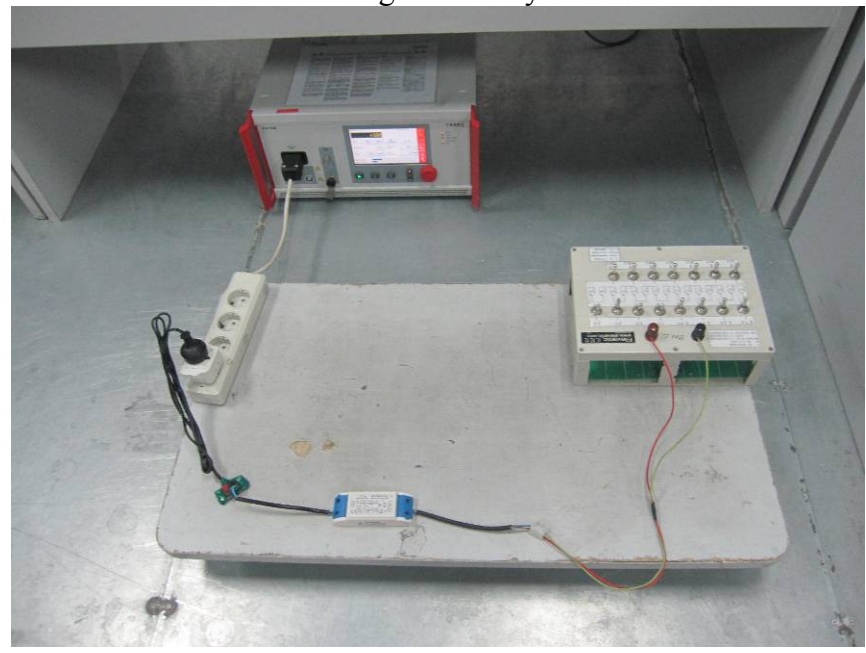

EFT & DIP Immunity

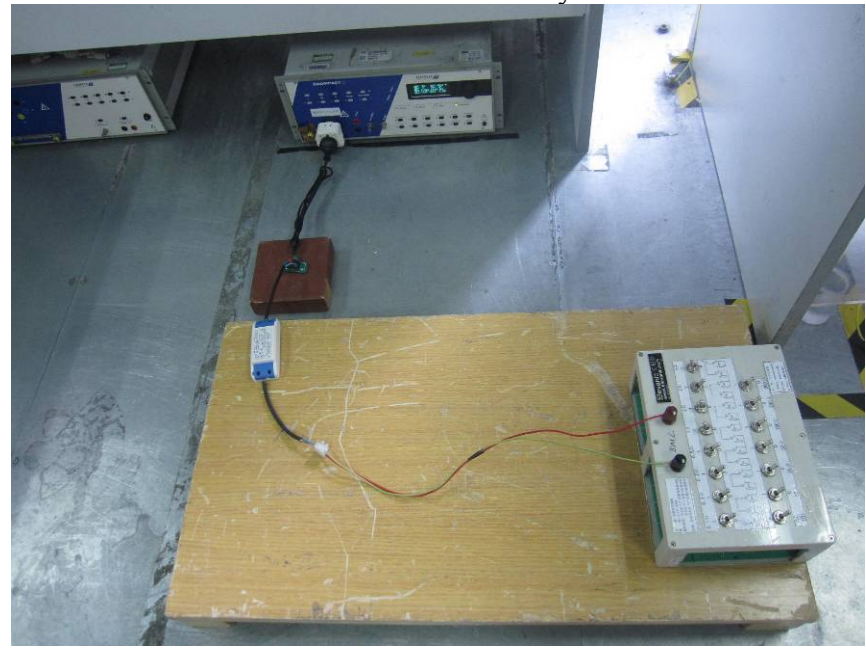

Conducted Immunity

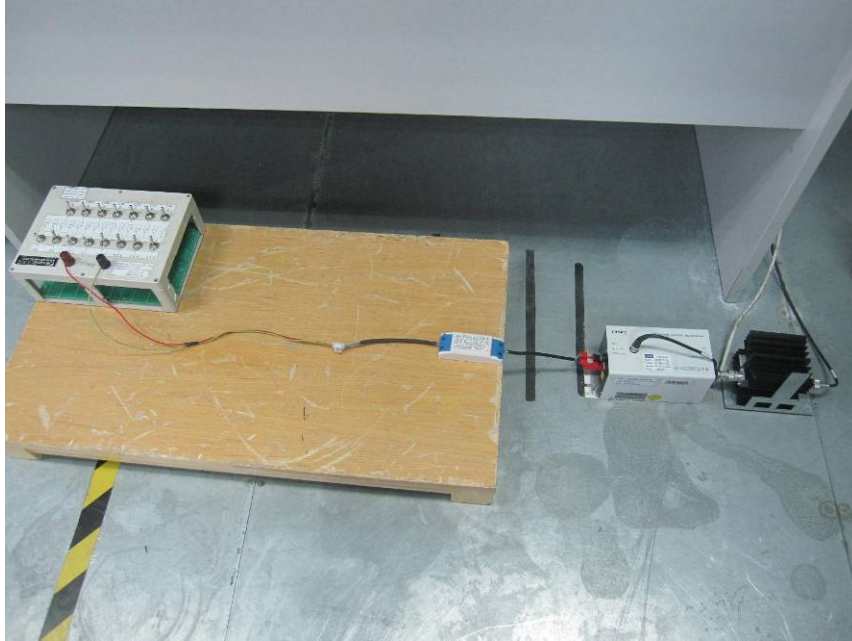

Radiated field Immunity

